



FULL CIRCLE
P A D D I N G . C O M

2020 CATALOG

Due to current circumstances all products are subject to change without notice.
To view current pricing and product availability please copy and paste item number in the search bar at www.Fullcirclepadding.com



CELEBRATING
35 YEARS
1985 - 2020

ACCESSORIES & FREEWEIGHT PARTS

FOR GYMS, HEALTH CLUBS, FITNESS CENTERS & PERSONAL TRAINERS

www.FullCirclePadding.com

1-800-875-7780

www.FullCirclePadding.com

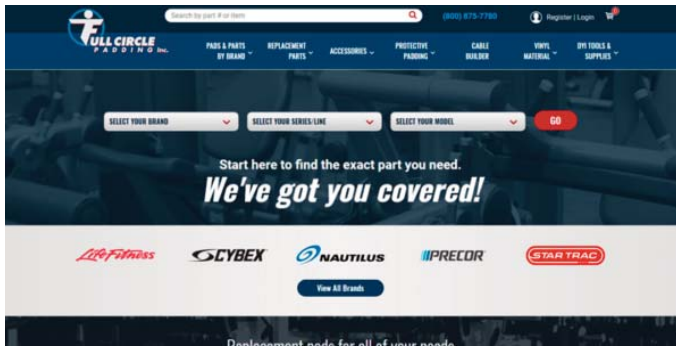

- Simple, secure online ordering for pads, accessories and replacement parts

- **NEW FEATURE** Order custom cables online! Click on Cable Builder and follow a few simple steps.

- Create an online account and have your order history available anytime.

For over 30 years Full Circle Padding, Inc. has proudly offered quality products and services to our customers. We greatly appreciate your support and look forward to working with you for years to come.

Our website, www.FullCirclePadding.com, is a valuable tool for our customers. You can create an account, order pads, parts or accessories online, check prices or simply view and print out our catalog. As always, equipment padding continues to be our specialty. On-site upholstery is available in the Northeast and pads are available to be shipped throughout the US and the world. Our selection of replacement pads available for purchase online has expanded greatly since the website began and is constantly updated to include new manufacturers.

We are very excited about the additions and improvements we continue to make to our catalog and our website. We strive to make ordering fast and easy for all our valuable customers. Our new website has even more features to make ordering even faster and easier. Such as our new Custom Cable Builder, chose your cable and ends, put in the length and your ready to order. As always if you cannot find something you are looking for or if you have any questions or comments please give us a call. We would love to hear from you.

Sincerely,
Chuck and Colin Rogers and the Entire Full Circle Team!

253 Mansfield Ave - Norton, MA 02766
Toll Free 1-800-875-7780
(508) 285-2500
Fax (508) 285-2502
www.fullcirclepadding.com

TABLE OF CONTENTS

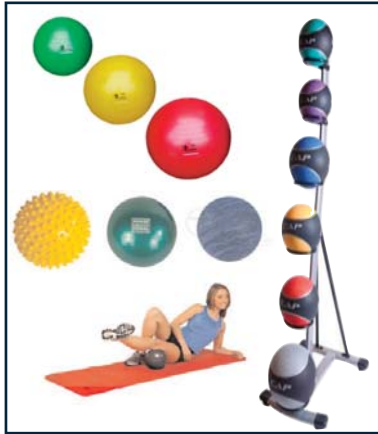

Aerobics & Group Exercise	.25-26
Aquatic Training	.24
<hr/>	
Balls & Ball Racks	.9-12
Belting, Cord, Grip Tape	.55
<hr/>	
Cable Attachments	.2-7
Cable Supplies & Tools	.58-59
Cleaning Products	.62-64
Crosscore	.23
<hr/>	
Dumbbell & Kettlebells	.36-38
Dumbbell & Kettlebell Racks	.39-41
<hr/>	
Fitness Charts	.27-29
Freeweight Parts	.48-49
<hr/>	
Grips	.57
<hr/>	
How to Measure a Custom Cable	.60
How to Measure Custom Pads	.68-69
<hr/>	
Lubricants	.62
<hr/>	
Olympic Bars	.46-47
Olympic Plates	.44-45
Olympic Collars	.46
<hr/>	
Personal Training	.13-22
Plastic Caps	.50
Pop Pins	.52
Power Lifting	.42-43
Pro Style Dumbbells	.37
Protective Guards	.56
Protective Padding	.33-35
Protective Padding Quote Request Forms	.72-76
Pulleys	.54
<hr/>	
Rubber Caps & tips	.51
Rubber Floor Mats	.30
Replacement Pads	.66-67
<hr/>	
Scales & Diagnostics	.8
Stretch Mats	.31-32
Suspension Training	.23
<hr/>	
Threaded Knobs & Screw Down Knobs	.53
Tools	.65
<hr/>	
Wall Pads	.34
Weight Stack Pins	.61
<hr/>	
Yoga	.13-14

Availability and cost of all products are subject to change without notice.
Full Circle is not responsible for typographical errors or omissions.

CABLE ATTACHMENTS



A. 60° REVOLVING STEEL LAT BAR

Knurled polished chrome finish with rubber grips for durability. 14 lbs
OMBT160RE

B. 48° REVOLVING LAT BAR

30 degree angle bends and swivel. Polished chrome finish with screw on rubber bumper ends for firm gripping. 11.5 lbs
OMBT148RE

C. 48° LAT BAR

48" Bar polished chrome bar with 30 degree angle bends. Does not swivel. 4.5 lbs
OMBT148

D. 48° REVOLVING STEEL LAT BAR WITH PVC GRIPS

30°angle bends with heat-treated steel swivel for durability. Bar has full length PVC grips.
OMBT148REWG

E. 48° REVOLVING STEEL LAT BAR WITH PVC GRIPS & CAPS

30°angle bends with heat-treated steel swivel for durability. Bar has full length PVC grips and aluminum grip caps.
OMBT148REWC

LIFE FITNESS DUAL PULLEY LAT BAR

Special order from manufacturer, allow 10 - 14 days for shipping.

F. For CMPD, MJLPD 9 1/2" between attachment points.

LF502-DS

G. For SM15, 5 1/2" between attachment points.

LF503-DS

H. LIFE FITNESS LONG BAR ASSEMBLY

Used on: SM22 Dual Adjustable Pulley, CMDAP Dual Adjustable Pulley, OSDAP Dual Adjustable Pulley. Special order from manufacturer allows 10 - 14 days for shipping.

LF830-DS

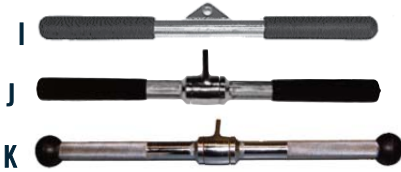

I. 18" STRAIGHT BAR

Hollow bar with chrome finish and rubber grips. Does not swivel. 3 lbs
OMBT018H

J. 18" STRAIGHT BAR

Hollow, revolving straight bar with foam grips. 3 lbs
OMBT018RH

K. 20" STRAIGHT BAR

Multi purpose "deluxe" solid revolving bar. 4.5 lbs
OMB020RE

L. 26" SOLID REVOLVING CURL BAR

Multi purpose deluxe revolving curl bar. 7.5 lbs
OMB228R



M. 28" HOLLOW REVOLVING CURL BAR

Polished chrome finish with rubber grips. 4 lbs
OMBT228RH

N. POWER SYSTEMS BLACK CHROME 28" CURL BAR

Black chrome finish with diamond patterned knurling provides a solid and consistency grip without being abrasive. Constructed from top quality steel. Universal design fits all cable machines.

061939-DS

O.TKO 28" CURL BAR

Chrome bar with polyurethane grips.

0820TCB-DS



CAMBERED PRO-STYLE LAT BARS

Solid steel with polished chrome finish. Knurling on handles.

P. OMBT438R 38" long 12.5 lbs

Q. OMBT428R 30" long 8.5 lbs

R. TKO PRO STYLE LAT BAR

38" long chrome with revolving center and multiple polyurethane grips.
0820TAL38-DS



S. TKO PRO STYLE LAT BAR

30" long chrome with revolving center and multiple polyurethane grips.

0820TAL30-DS

STRAIGHT PRO-STYLE BARS

Straight Pro-Style Lat Bar w/forged swivel - solid ERGO handle.

T. 34" long 10 lbs

OMB434R

U. 24" long 8 lbs

OMB424R



CABLE ATTACHMENTS



A. POWER SYSTEMS BLACK CHROME STIRRUP HANDLE

The next generation of cable attachments from Power Systems featuring all black chrome fit and finish. Diamond patterned knurling provides a solid and consistency grip without being abrasive. Constructed from top quality steel. Universal design fits all cable machines.

061942-DS

B. STEEL STIRRUP HANDLE

Steel handle with new ERGO handle. 2 lbs

OMB501

C. DELUXE REVOLVING STIRRUP HANDLE

Solid steel heavy duty stirrup handle with ERGO grip and chrome finish. 3 lbs

OMB506

D. WIDE GRIP CHINNING TRIANGLE

The solid Chinning Triangle is designed for backs and shoulders. It features a chrome finish and has a 7-1/2" wide grip. 4 lbs

OMB502W

E. CYBEX HOLLOW CHINNING TRIANGLE WITH GRIPS

Grips are replaceable. 3lbs

OMB502HWG

F. HOLLOW CHINNING TRIANGLE

5" Grip. 3 lbs

OMB502H

G. SOLID CHINNING TRIANGLE

4.5" long grip. Designed for backs and shoulders. 3 lbs

OMB502



H. SOLID V BAR

Solid steel with chrome finish and grips. Does not swivel. 5 lbs

OMB320E

I. DUAL PURPOSE BAR

Concentrated extra wide grip for back and shoulder development. 5.5 lbs.

OMB505

J. TRICEP PRESSDOWN BAR

Provides excellent tricep extension and contraction. 4 lbs

OMB504

K. REVOLVING TRICEP / BICEP BAR

Solid steel, polished chrome finish with knurling. - 3/8" thick stock steel plates. 6 lbs

OMB504R

L. POWER SYSTEMS BLACK CHROME TRICEPS PUSHDOWN BAR

Featuring all black chrome finish with diamond pattern knurling. Constructed from top quality steel. Universal design fit all cable machines.

061941-DS

M. TKO CHROME TRICEP BAR

Chrome bar with polyurethane grips

0820TPD-DS

N. MULTI EXERCISE BAR

Most versatile piece for seated rows, tricep pressdown and bicep curl. Revolving. 8 lbs

OMB503RE

O. WIDE ANGLE TRICEP / BICEP BAR

Revolving 6 lbs

OMB506

P. SOLID REVOLVING TRICEP BAR WITH ANGLED ENDS

Solid steel with chrome finish and grips. 5.5 lbs

OMB321R

Q. SOLID REVOLVING TRICEP BAR

Solid steel with chrome finish and grips. Provides constant tension throughout the exercise. 5 lbs

OMB322R



R. SUPRABAR SPREADER BAR

This unique cable attachment bar brings the ultimate workout to you in one attachment. This attachment can be hooked onto to lower cable station of any standard cable system isolating the arm and chest muscles. While you work out, turn the handles for even more range. Hook the spreader bar to the upper attachment of any cable system and turn the spreader bar into an excellent triceps extension, over-head extension or many other workout routines. You are pretty much in control of whatever type of multiple exercises you want to do without the stress on tendons and joints. Ships direct from manufacturer. 7 lbs

OSBPR22-DS

S. 23" CABLE CURL BAR

Designed to increase upper arm mass, strength and definition. Instead of using 2" Olympic size weights, the 23" cable curl bar attaches onto any cable system allowing the user to concentrate on biceps without the stress of tendons and joints. Ships direct from manufacturer. 16 lbs

OSBCB23-DS

T. BUTTERFLY TRI-BAR

This small triceps press down bar hooks onto any standard cable system and produces an unbelievable triceps workout. Ships direct from manufacturer. 12 lbs

OSBTB10-DS



CABLE ATTACHMENTS

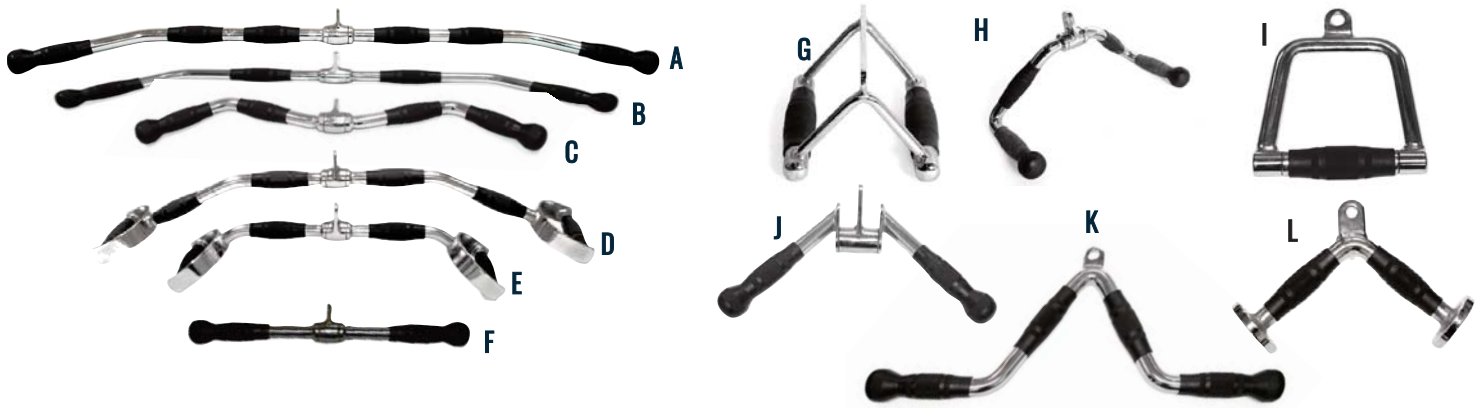

DELUXE CABLE ATTACHMENTS

All attachments below are revolving bars with contoured rubber handgrips.

A. 48" LAT BAR

48" long, 12 lbs
OMBR148R

B. 36" LAT BAR

36" long, 10 lbs
OMBR136R

C. 28" CURL BAR

28" long, 8 lbs
OMBR228R

D. 38" CAMBERED PRO STYLE BAR

38" long, 13 lbs
OMBR438R

E. 24" STRAIGHT PRO STYLE BAR

24" long, 10 lbs
OMBR424R

F. 20" STRAIGHT BAR

20" long, 6 lbs
OMBR020R

G. CHINNING TRIANGLE

7" x 6" x 5", 4.5 lbs
OMBR502

H. MULTI EXERCISER BAR

17" x 8" x 8"
OMBR503R

I. STIRRUP HANDLE

8" x 7" x 2", 3 lbs
OMBR506

J. TRICEP PRESS DOWN BAR

23" long, 7 lbs
OMBR320

K. MULTI PURPOSE BAR

17" x 9" x 2", 6 lbs
OMBR322R

L. TRICEP PRESSDOWN BAR

13" X 7" X 3", 5 lbs
OMBR504



M. VERTICAL ACCESSORY ATTACHMENT RACK

The VDRA30 is perfect for storing and organizing multiple accessory bars, ropes, straps and even dumbbells. The rack can hold up to 36 items in a very efficient and compact space. 36"H x 14"W x 14"L. 70 lbs
0VDRA30DS

N. FCP PACK

Body Solid Vertical Attachment Rack with 15 of our most popular attachments. Perfect starter pack for any gym or personal training facility. Rack ships direct from manufacturer. Includes:

- | | |
|--|----------------------------------|
| 1- Body Solid Vertical Attachment Rack | 1- Wide Angle Tricep/Bicep Bar |
| 1- 48" Revolving Steel Lat Bar | 1- Tricep Pressdown Bar |
| 1- 20" Solid Revolving Straight Bar | 1- Multi-Exercise Bar |
| 1- 26" Solid Revolving Curl Bar | 1- Chinning Triangle |
| 1- 38" Cambered Pro-Style Lat Bar | 1- Tricep Rope with Rubber Balls |
| 1- 30" Cambered Pro-Style Lat Bar | 2- Steel Stirrup Handle |
| 1- Solid V-Bar - No Swivel | 2- 10" Nylon Stirrup Handle |

0FCPACKBS



O. TAG ACCESSORY RACK

FREE SHIPPING IN THE CONTINENTAL USA!

Holds all types of fitness accessories and cable attachments. Lifetime warranty on welds and one year on parts against manufacturing defects. Size 49" x 27" x 24"
0RCKACR-DS



A. ADJUSTABLE STIRRUP HANDLE WITH HAND SUPPORT

1 1/4" grip. 1 lb
ONPT2

B. NYLON STIRRUP HANDLE WITH 11/4" ERGO HANDLE

10" long (pictured) 5 1/2" handle. 1/2 lb
OH835A
14" long (not pictured) 5 1/2" handle. 1/2 lb
OH835C
19" long (not pictured) 5 1/2" handle. 1/2 lb
OH835D

C. NYLON STIRRUP HANDLE WITH 2 "D" RINGS

Measures 14" long with a 1 1/4" grip. 2 - "D" rings to adjust length. Adjusts from 7" to 14", 5 1/2" handle. 3/4 lbs
OH835E

D. 10" NYLON STIRRUP HANDLE WITH 2" PVC GRIP

1/2 lb
OH834B

E. 7" FREEMOTION STIRRUP HANDLE WITHOUT D RING

This strap is 7" long with a 1 1/4" ergo grip. (Used on Lat/Lift) 1 lb
FM500

F. 7" STIRRUP HANDLE WITH D RING

Strap is 7" long with an ergo grip. Handle measures 1 1/4" in diameter. For Freemotion Cable Cross / Cable Column / Dual Cable Cross or other equipment. 1 lb
FM560



G. FREEMOTION ADJUSTABLE NYLON STIRRUP HANDLE

Adjustable Stirrup Handle with 2 D-Rings (7" or 14") For use with Freemotion Chest / Cable Cross or other machines. 1 lb
FM520

H. 26" NYLON STIRRUP HANDLE WITH 3 "D" RINGS

Measures 26" long with a 1 1/4" grip. 3 "D" rings to adjust length. 1lb
FM501

I. 30" NYLON STIRRUP HANDLE

Does not have D ring. 1lb
FM530

J. 30" NYLON STIRRUP HANDLE WITH D-RING

Measures 30" long with a PVC Grip. Handle measures 1 1/4" in diameter. 1 lb
FM540

K. EXTRA LONG 24" TRICEP STRAP WITH 1 1/4" GRIP

1 lb
ONTS20

L. EXTRA LONG 24" TRICEP STRAP WITH 2" GRIP

Same as above (not pictured) 1 lb
ONTS20B

M. 20" MULTIPURPOSE HANDLE

Use on one end for sport related exercises. The handle is a rigid 1 1/4" grip with "D" ring at each end. Also available with 2" grip, call for more information. 2 lb
ONPT1

NYLON HANDLES & STRAPS

All handles show on this page are manufactured by Full Circle Padding in the USA!



A. 18-1/2" STRAP WITH 3 D-RING

Strap has 3 different lengths to choose from 18-1/2", 16-1/2" and 14-1/2". Grip handle measures 5-1/2" x 1-1/4" in diameter. 1/2 lb
LF750

B. NYLON WRIST/ANKLE STRAP WITH D-RING

Nylon strap with no padding, Available in black only. 3 lbs
NA146A

C. PADDED WRIST / ANKLE STRAP WITH D-RING

Strap with padding. Available in black only. 3/4 lbs
NA146P

D. NAUTILUS MULTI-EXERCISER PADDED WAIST BELT

Measures 4" x 32" with large D ring. 3 lbs
NA146

E. PRECOR ADJUSTABLE NYLON STIRRUP HANDLE

Adjustable length to either 12 1/2" or 10 1/2". Has 1 1/4" grip. 3/4 lbs
PRE450



F. PRECOR ADJUSTABLE NYLON STIRRUP HANDLE

Adjustable length to either 22" or 18". Has 2" grip. 1 lb
PRE455

G. NYLON STIRRUP HANDLE WITH STRAP

This strap has a 5-3/4" ergo grip and vinyl foot strap. This handle is great for multiple exercises. Can be used for CrossCore 180 or War Machine Rotational Body Weight Training System. 3/4 lb
WM100R

H. FOOT HARNESS

Hamstring foot harness with padded ankle strap cover. 2 lbs
FM506

I. PAIR OF FOOT STRAPS

Foot Straps are left and right. Straps are designed with a velcro closure that fastens on the outside of each foot. 3/4 lb
ONFS30PAIR

J. POWER PLATE STRAP WITH HANDLE

This strap is manufactured by Full Circle and replaces the original Power Plate Strap. 1 lb
PP001

CABLE ATTACHMENTS



A. TRICEP ROPE WITH WOODEN BALLS

Heavy duty rope with wooden ends. Use to do heavy press downs, curls, crunches, kickbacks and deltoid raises. 1.5 lbs 1.5 lbs
OTR20

B. 18" NYLON TRICEP STRAP

Can be used for tricep press downs, ab crunches, bicep curls, tricep extensions, front and side deltoid raises and much more. Nylon with neoprene padding. 1 lb
ONTS10

C. SINGLE TRICEP

Heavy duty single pull rope with rubber end. 1 lb
OTR20R1

D. TRICEP ROPE WITH RUBBER BALLS

Heavy duty rope with rubber ends. Use to do heavy press downs, curls, crunches, kickbacks and deltoid raises. 1.5 lbs
OTR20R

E. LEATHER TRICEP STRAP

Use for tricep press downs, ab crunches, bicep curls, tricep extensions, front and side deltoid raises and much more. Edges will not pinch or scrape, neoprene lining allows the hand to breath. 75 lb capacity. 1lb
OMA325

F. NYLON TRICEP ROPE

The Nylon Tricep Rope can be used for tricep extensions, tricep pressdowns, bicep curls and ab crunches. Constructed of nylon rope which is knotted to prevent hands from slipping. The ends of the rope are capped with a black rubber tip. Rope has a overall length of 30" and is 23" between knotted ends.
OTR20N

G. 7 1/2" PROFESSIONAL AB SLINGS

Use for toning, trimming and conditioning of the entire abdominal area without lower back strain. Slings are 7 1/2" wide with a soft fabric lining and heavy solid steel locking carabiners. 300 lb capacity 3 lbs
OHHDFS001

H. TKO AB SLING

Designed with 7" padded straps and heavy duty carabiners. The durable heavy duty woven nylon is sure to last. Sold as a pair
0147ABS-DS

I. DELUXE AB CRUNCH HARNESS

Extra-wide padded harness protects the neck, shoulders, back and chest while you concentrate on your abs and obliques. Comfortable foam grips offer quick and easy hand positioning. Heavy-duty solid steel "D" ring for strength and durability. 2 lbs
0ACH18

J. AB CRUNCH STRAP

Maximize abdominal development with the Ab Crunch Strap. The strap is sewn with heavy duty stitches and heavy duty hand grips. Ideal for most home gyms. 150 lb capacity 1 lb
OMATB403



K. LEATHER DIPPING BELT

Leather with welded chain and snap hooks. 2.5 lbs
OMA330

EXTRA SMALL SNAP CLIP

(not pictured) Use in place of snap hook on dipping belt. .5 lbs
FW123

L. LEATHER HEAD HARNESS

Conditions the neck and upper back muscles. Padded with high density neoprene to absorb shock and prevent cuts, chafing and abrasion. 2.5 lbs
OMA307

M. LEATHER DIPPING STRAP

1 lb
OMA310



N. WEIGHT BELTS

The 4" Harbinger padded leather belt was designed for medium to heavy lifting. Belt will support your back while engaging the abdominal muscles as well as contour around the hips and ribs helping to prevent injury. 2 lbs.

065416-DS
065417-DS
065418-DS
065419-DS

O. TKO ANKLE STRAP

The TKO Neoprene Ankle Strap has an adjustable loop and hook closure with a black D-ring for attachment. The strap is neoprene padded for extra comfort.

P. TKO ULTIMATE ANKLE STRAP

The TKO Ultimate Ankle Strap comes with a 2 black D-rings for attachment as well as comfortable synthetic sheepskin padding.

0106HBK-DS

Q. LEATHER ANKLE STRAP

Designed for hip and thigh toning. Leather with buckle closure. 1/2 lb
OMA308

R. NYLON ANKLE STRAP

Designed for hip and thigh toning. Nylon with velcro closure. 250 lb capacity. 1/2 lb
OMAT404

All items on this page ship direct from the manufacturer.



DETECTO 400 LB BEAM SCALE

The Detecto scale is the scale you see in most doctor offices, health clubs, hospitals and other facilities. The Clinical Scale is a balance beam scale that weighs up to 400 lbs. in 4 oz. increments. It's roomy platform is 10.5" x 14.5". 70lbs.

- A. 0CRD100WHT-DS
- B. 0CRD108WHT-DS

C. DETECTO 350 LB EYE LEVEL BEAM SCALE

The low profile, Detecto Eye Level Scale is a great design for a doctor's office, health club or other facility. As a standard balance beam scale, the Detecto can weigh up to 350 lbs. in 1 lb. increments. It features a large, easy-to-read 7" dial and adjustable scroll to set the zero point and balance. Its compact, slip-resistant platform is 10.6" x 10.6", so it fits well in small spaces. 50 lbs 0CRD138-DS



D. HEALTH O METER DIAL SCALE

This scale by Health O Meter gives a precise and accurate weight measurement with no batteries to replace. The heavy duty steel base features an extra large platform with a non-slip texture. 8" diameter easy to read dial with large numbers. 1 year limited warranty. 400 lb capacity, 1 lb graduations. EQHLM160KL-DS



E. MINI CALORIE PEDOMETER

Track distance in miles or kilometers while walking or jogging. Functions include: a step and lap counter, stopwatch function, real time clock setting and calorie counter that allows user to input their wait for a more accurate reading. The protective clamshell case is lightweight and clips to waist band or belt. Replaceable battery included. 1 lb EQPED-DS



F. HEART START ONSITE DEFIBRILLATOR

This defibrillator is designed for the ordinary person with minimal training. It is safe, reliable and effective. It performs self-tests on its battery, pads and internal circuits to ensure readiness. Clear natural voice instructions guide you through the process including CPR. Battery powered by a long life (four year) battery. Ships direct from manufacturer.

Safe: Designed so it is virtually impossible to "shock" someone who is not in SCA.

Reliable: Performs self-tests, daily, weekly and monthly.

Effective: Delivers low-energy biphasic therapy, highly effective defibrillation waveform that is gentle on the heart.

EQQLPM5066A-DS



G. HEART START ONSITE DEFIBRILLATOR BATTERY

The battery's shelf life is typically four years, and the "install by" date is printed on the battery for easy reference. Use of HeartStart, it's training cartridges, additional battery insertion tests or exposure to harsh environments may shorten the battery life. One per package, no recharging needed. Ships direct from manufacturer.

EQQLPM5070A-DS

BALLS & BALL RACKS



A. ANTI-BURST FITNESS BALL

Stability balls help to improve alignment, stability and strength. Also great for yoga, stress relief and stretching. The weight of the person using the ball with any weights, dumbbells or barbells being used should not exceed 600 lbs of weight. To determine ball size you should be able to sit on the ball with your hips and knees forming a 90 degree angle.

- 0BALL55AB** 55 cm Green
- 0BALL65AB** 65 cm Yellow
- 0BALL75AB** 75 cm Red
- 0BALLABSET3** Set of 3, 1 each; 55 cm, 65 cm, 75 cm, 12 lbs



FITNESS BALLS

Suggested ball size based on height:

- 45 cm4' 6" to 5' 0"
- 55 cm5' 1" to 5' 6"
- 65 cm5' 7" to 5' 11"



B. POWER SYSTEMS VERSABALL

For quality and durability, this professional-grade stability ball fits the bill for any fitness or athletic facility. Tape measure included to ensure proper inflation. Deflates slowly if punctured. Hand pump is not recommended with this item.

- 45 cm**
- 080006-4C-SG-DS** Sunrise Gold
- 080006-4C-JB-DS** Jet Black
- 75 cm**
- 080006-7C-JB-DS** Jet Black

C. BODY SPORT - STUDIO SERIES FITNESS BALLS

Built to last, even in a demanding environment like a busy health club, the professional Exercise Balls are exactly what you'd expect from Body Sport – with a few extras. Body Sport's professional Exercise Balls have a gently ridged surface to promote secure gripping, as well as slow air deflation. Made in charcoal grey.

- 0BDSBULK45ABCMBLK-DS** 45 cm
- 0BDSBULK55ABCMBLK-DS** 55 cm
- 0BDSBULK65ABCMBLK-DS** 65 cm
- 0BDSBULK75ABCMBLK-DS** 75 cm



GRAY PVC BALL RACKS

Free-standing stability ball racks keeps your exercise area safe and organized. Rack will hold, 8 stability balls from 45 cm to 85 cm. Also referred to as stability ball trees, these ball holders are designed so they can be placed on the corner and out-of-the-way and the base is wide and sturdy so it does not topple over. Lightweight and sturdy. Hard PVC tubing. Gray with black. Assembly required.

D. POWER SYSTEMS 8 BALL RACK

- 092478L1-DS** 8 Ball Rack
- 092478L2-DS** 8 Ball Rack with casters

E. POWER SYSTEMS STABILITY BALL WALL STORAGE RACK

Keep your stability balls off the floor when not in use. Holds up to 4 stability balls. Wall-mounted design provides easy access. Hard PVC tubing with cable wall attachments.

Gray. Dimensions: 105" length x 21" width. Assembly required (mounting hardware not included)

092579-DS

F. POWER SYSTEMS ELITE STABILITY BALL WALL STORAGE RACK

Add an attractive design to your facility with this NEW all metal hanging ball rack. Holds up to 4 stability balls. Assembly required. Mounting hardware not included. 99" long

092478-DS

G. POWER SYSTEMS BALL BASE

Stability balls (also often called exercise balls or Olympic core balls) are a great way to improve your strength, cardio endurance, and balance. By performing basic exercises like push-ups, squats, planks, lunges, and roll-outs on the unstable surface of the exercise ball, your muscles get more bang for their buck. Adding a Power Systems Ball Base provides a bit more stability to the exercise ball for beginners, but also extends the possible uses of the product. Ships direct from manufacturer.

080610-DS - Large Base



BALLS & BALL RACKS



A. HEAVY DUTY AIR PUMP

Durable, dual action pump. Great for inflating multiple balls.
2 lbs
ORPAP-DS



MEDICINE BALLS

Our medicine balls bounce, making them perfect for building coordination, strength and stamina. Six different weights and colors.

BEGINNER LEVEL

Fitness classes, one handed exercises

C. **OHHK002** 2 lb Green / Black

D. **OHHK004** 4 lb Purple / Black

E. **OHHK006** 6 lb Blue / Black

INTERMEDIATE LEVEL

Advanced fitness classes, two handed throw, passing exercises

F. **OHHK008** 8 lb Yellow / Black

G. **OHHK010** 10 lb Red / Black

ADVANCED LEVEL

Two handed throw, passing exercises, two handed strength type exercises

H. **OHHK012** 12 lb Gray / Black

RACKS WITH BALLS

2, 4, 6, 8, 10, 12 LB BALLS & RACK

Set includes one six ball rack and one each 2 lb, 4 lb, 6 lb, 8 lb, 10 lb, and 12 lb balls. 65 lbs.

OHHKS42-DS

I. 6 MEDICINE BALL SPINAL RACK

(Pictured with balls) This gray and black ball rack from CAP Barbell Holds one of each size ball listed above. Assembly required.

Balls not included. 25 lbs

OHHKCRK6

J. POWER SYSTEMS 3 TIER MEDICINE BALL RACK - BLACK

Store medicine balls of all different sizes with the 3-Tier Med ball rack. Trays increase in width from top to bottom. Store up to 21 balls with an 8" diameter or 15 balls with an 11" to 12" diameter. Locking casters for easy transport and storage. Steel construction. Assembly required. 58" L x 20 1/2" W x 38" H. Ships in 2 boxes. Additional shipping may apply. Balls sold separately.

027188-DS



Medicine Balls Not Included

K



K. POWER SYSTEMS ELITE POWER MEDICINE BALLS

The NewElite Power Medicine Ball Prime features a textured grip surface and provides a strong, quick rebound for speed and power training. Eleven different weights complete the set - all a consistent 11" diameter. The color-coded seams identify each weight while maintaining the clean, modern monochrome look facilities crave.

025560-DS 2lb
025561-DS 4 lb
025562-DS 6 lb
025563-DS 8 lb
025564-DS 10 lb
025565-DS 12 lb

025566-DS 15 lb
025567-DS 18 lb
025568-DS 20 lb
025569-DS 25 lb
025570-DS 30 lb

L



L. TKO MEDICINE BALL RACK

The TKO Medicine Ball Rack is designed to fit in the corners of the room taking up less valuable floor space. This rack is made with oversized round tubing for the commercial setting and holds upto 10 medicine balls.

Assembled dimensions 35" W x 30" D x 54" H

0849MB10-DS

BALLS & BALL RACKS



A



B



C

A. POWER SYSTEMS MED BALL TREE WITH BALLS

Set includes: 2lb, 4lb, 6lb, 8lb, 10lb Elite Power Medicine Ball Prime and a space saving rack. Elite Power Medicine Ball Prime features a textured grip surface and provides a strong, quick rebound for speed and power training. Eleven different weights complete the set - all a consistent 11" diameter. The color-coded seams identify each weight while maintaining the clean, modern monochrome look facilities crave. Space-saving vertical design uses minimal floor space. Stores up to 5 medicine balls measuring up to 11" diameter. Place in a group setting or weight room where multiple balls and ease of access are needed. Tubular steel construction. Assembly required. 14" L x 11" W x 52" H.

025200SET-DS Rack with balls

027152-BK-DS Rack only

B. TROY BARBELL VTX FITNESS BALL RACK

This rotational rack makes selecting the balls easy and allows it be p for increased space and efficiency. Holds 12 balls. 600lb weight capacity. Ships direct from manufacturer. 75 lbs

0GWBR

C. POWER SYSTEMS PREMIUM MEDICINE BALL RACK

Holds 20 balls. Ball-bearing casters provide smooth transport and lock into position. Grey. Assembly required. Measures 25"L x 25"W x 56"H. Medicine Balls not included. Ships direct from the manufacturer in 2 boxes

027156-GA-DS

D. 6 MEDICINE BALL RACK

The new Body Solid medicine ball rack provides quality storage and design for just about any size medicine ball or dual grip medicine ball. It provides vertical storage for up to 6 medicine balls or 6 dual grip medicine balls. The rack fits medicine balls from 2lbs to 16 lbs and dual grip medicine balls from 6 lbs to 20 lbs. The curved oval upright allows for easy access to every tier. Heavy gauge steel provides a stable and durable frame. The silver powder coat finish and modern look shows off your accessories in style. At only 21" x 22" foot print, the rack is compact and functional. Ships direct from manufacturer.

0GMBR6-DS

E. 6 CAP MEDICINE BALLS WITH RACK

Includes: 2, 4, 6, 8, 10, and 12 lb Balls and 6 ball rack.

0GMBR6SET

F. 6 MEDICINE BALL RACK WITH BALLS

The new Body Solid medicine ball rack 0GMR10 provides quality storage and design for just about any size medicine ball. The 0GMR10 provides vertical storage for up to 6. The curved oval upright allows for easy access to every tier. Heavy gauge steel provides a stable and durable frame. The silver powder coat finish and modern look shows off your accessories in style. At only 21" x 22" foot print, the 0GMR10 is compact and functional. Includes Medicine Ball Rack, 4lb, 6lb, 8lb, 10lb, 12lb, 14lb Medicine balls. Height: 62" Length: 21" Width: 23" Ships direct from manufacturer.

0GMR10-PACK-DS

G. POWER SYSTEMS MEGA MEDICINE BALL STORAGE RACK

Stores up to 8 Dynamax Medicine Balls. This rack is the perfect solution to get your over sized medicine balls off the floor. This attractive rack holds 8 Dynamax medicine balls in a safe and secure manner. The space saving design allows users to retrieve a ball from any angle. 66"T x 21.5"W x 35.5"L. Gray. Ships direct from manufacturer.

024025-DS

H. POWER SYSTEMS 3 TIER MEGA MEDICINE BALL RACK

Keep your oversized medicine balls off the floor and out of the way with the 3 Tier Mega Medicine Ball Rack. This rack holds up to twelve 14 inch diameter medicine balls at one time! It can be easily moved to accommodate when your product is needed or pushed out of the way for added floor space in your gym or box. Ships direct from manufacturer. Measures 63.5" L x 16.5" W 43" H

024026-DS



D



E



F



G



H



A. SLAM BALLS

These are heavy duty sand filled balls that can be used for a variety of exercises. Slam Balls are designed with a tough rubber shell and filled with air and sand to create a no-bounce medicine ball which are thrown at the wall or floor. This ball has no bounce and will rest on the floor when slammed, reducing injuries. An improved texture also

give you better grip when handling the slam ball. Available from 10 lbs. to 30 lbs in 5 lb increments.

- 0SB10** 10 lb
- 0SB15** 15 lb
- 0SB20** 20 lb
- 0SB25** 25 lb
- 0SB30** 30 lb
- 0SBBALLSET** 1 of each size 10, 15, 20, 25, 30 lb



B. TKO TYRESLAM BALL

made with a durable rubber shell and a tire like tread surface for better grip. These slam balls are made to withstand even the toughest workouts. Comes in various sizes and can be incorporated into any workout routine.

- 0509SBT06-DS** 6 lb
- 0509SBT08-DS** 8 lb
- 0509SBT10-DS** 10 lb
- 0509SBT12-DS** 12 lb
- 0509SBT15-DS** 15 lb
- 0509SBT20-DS** 20 lb
- 0509SBT25-DS** 25 lb
- 0509SBT30-DS** 30 lb
- 0509SBT40-DS** 40 lb
- 0509SBT50-DS** 50 lb



C. POWER SYSTEMS MEGA SLAM BALLS

This no-bounce, no-roll slamball is specifically designed for high-impact throwing and slamming to the ground. This ball is a must-have to any cross-training regimen. You can use in place of a standard medicine ball to perform traditional core exercises or pass back and forth with a partner. The rugged, textured surface provides superior grip, handling and long life.

- 025430-DS** 10 lb
- 025432-DS** 15 lb
- 025434-DS** 20 lb
- 025435-DS** 25 lb
- 025436-DS** 30 lb
- 025430SET-DS** Slam Ball Set, 1 each 10, 15, 20, 25 and 30 lb ball
- 025430RACKSET-DS** Mega Slam Ball Set with Rack and 10, 20, 25, 30 lb balls
- 025437-DS** 35 lb
- 025438-DS** 40 lb
- 025439-DS** 45 lb
- 025440-DS** 50 lb

D. WALL BALL

Overstuffed to maintain shape and softness, these balls can be thrown and caught at high speeds with peace of mind. All wall balls come in the same diameter of 14", progress with weight only while practicing various exercises that will help you excel in any sport or competition. Wall balls are triple stitched and provide a thicker textured shell for a better grip when compared to traditional PVC shells.

- 0WB08** 8 lb
- 0WB10** 10 lb
- 0WB12** 12 lb
- 0WB14** 14 lb
- 0WB16** 16 lb
- 0WB18** 18 lb
- 0WB20** 20 lb
- 0WB25** 25 lb



E. POWER SYSTEMS CORBALL PLUS MEDICINE BALLS



Medicine balls with dual hand grips combine an Elite Power Med-ball with a Power Grip-Ball for more functional, diverse training. Ideal for abdominal training, rotational movements, and strength training. The Plus offers solid molded handles with plastic textured grips for a more secure, comfortable hold and greater durability under intense training conditions.

- 028305-06-DS** 6 lb
- 028305-08-DS** 8 lb
- 028305-10-DS** 10 lb
- 028305-12-DS** 12 lb
- 028305-14-DS** 14 lb
- 028305-16-DS** 16 lb
- 028305-18-DS** 18 lb
- 028305-20-DS** 20 lb
- 028305-25-DS** 25 lb
- 028305-30-DS** 30 lb

F. POWER SYSTEMS SOFT TOUCH MED BALL

Add resistance to a variety of exercises, or use in rehabilitation. Medicine ball fits in the palm of the hand allowing you to move freely through a full range of motion during exercise. Perform a wide range of upper- and lower-body exercises including crunches, rotational twists, and leg raises. Durable outer shell made of pliable PVC contains filler. Balls do not bounce and are not intended for throwing. Color coded by weight; colors may vary. 5-1/2" diam. (1 lb. to 5 lb. balls); 6-1/2" diam. (6 lb. to 10 lb. balls).

- 026150-01-DS** 1 lb - Pink
- 026150-02-DS** 2 lb - Yellow
- 026150-03-DS** 3 lb - Gray
- 026150-04-DS** 4 lb - Green
- 026150-05-DS** 5 lb - Blue
- 026150-06-DS** 6 lb - Black





A. POWER SYSTEMS MYO THERAPY BALL

These air-filled balls compress gently and offer a smooth, comfortable surface when used for positioning. Made of soft PVC. Available in 6" and 8". Balls ship deflated

- 0806816IBK-DS 6" Black
- 0806816IRE-DS 6" Red
- 0806818IBK-DS 8" Black
- 0806818IRE-DS 8" Red

B. POWER SYSTEMS MYO-RELEASE BALL

Firm and solid, these lightweight, uncrushable myofascial release balls keep their shape and do not absorb moisture or bacteria. Made of heat-sealed, closed-cell EVA foam. Use the Myo-Release Ball™ in myofascial release exercises and movements to assist in equalizing muscle tension throughout the body. The different sized balls allow you to treat trigger points based on their size or sensitivity. The larger balls let you spread the force out over the muscle area, and the smaller balls allow you to target only a small part of the muscle and penetrate the tissue more deeply.

- 0802746IMB-DS 6" Blue
- 0802746IBK-DS 6" Black
- 0802748IMB-DS 8" Blue
- 0802748IBK-DS 8" Black

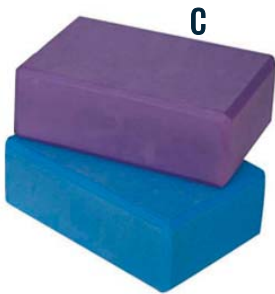

C. POWER SYSTEMS YOGA BLOCK

These lightweight, durable foam blocks are a perfect tool for additional support during transitions and poses. The six sides of the Yoga Blocks are three different sizes. Use the side that is sized to meet your needs and goals. Ships direct from manufacturer. 1 lb

- 0833553NBL-DS 9" x 6" x 3" - Blue
- 0833553NPU-DS 9" x 6" x 3" - Purple
- 083354NBL-DS 9" x 6" x 4" - Blue
- 0833554NPU-DS 9" x 6" x 4" - Purple

D. POWER SYSTEMS YOGA STRAPS

Ideal for stretching and positioning. Allows the user to pull themselves into the proper asana or position. Also ideal for increasing flexibility. Made of strong cotton with PVC buckle. Ships direct from manufacturer.

- 0834158FPU-DS 8' - Purple
- 0834158FBL-DS 8' - Blue
- 0834156FPU-DS 6' - Purple
- 0834156FBL-DS 6' - Blue



E. POWER SYSTEMS PILATES RING

The Pilates ring is made of fiberglass and has a flexible foam cover and molded plastic handles to ensure a secure grip. Use the ring to do Pilates at home or at your fitness center during isometric exercises to enhance your pilates workout, firming the upper arms and thighs. Its 15-inch diameter is a comfortable size, and you have your choice of light, moderate, or firm resistance, depending on your fitness level. A set of three will ensure people of all fitness levels will have a ring appropriate for them. Lightweight and portable, they can be transported anywhere.

- 083921-DS Light
- 083922-DS Moderate
- 083923-DS Firm

A. POWER SYSTEMS PILATES REFORM BAR

The Reform Bar from Power Systems is a portable Pilates studio that allows you to perform Reformer-style movements without tons of equipment. Bar has two 30" long resistance tubes attached to each side so you can do a variety of movements with the attached Velcro-adjustable cuffs. All Power Systems brand tubing products are produced with a unique layering process to improve longevity in institutional or commercial settings. Medium resistance available. The 39'L bar disassembles to fit into carry bag with the tubing. Ships direct from manufacturer
084593-DS



A



B

B. POWER SYSTEMS PREMIUM YOGA STICKY MAT

Mats offer a secure adhesive, textured surface and firm, cushioned support. Lightweight and extremely durable, these mats are ideal for yoga as well as stretching and Pilates. Wipe clean with a damp cloth; roll for easy storage. Ships direct from manufacturer. 68" x 24", 2 lbs

1/4" THICK

- 0832016MBLQN-DS** Ocean Blue
- 0832016MJBQN-DS** Black

1/8" THICK

- 0832016MGNEH-DS** Tea Leaf Green
- 0832016MBLEH-DS** Ocean Blue

C. POWER SYSTEMS MAT CART

Stay organized with this movable storage unit that holds 120 thin mats 1/8" thick or 60 mats 1/4" thick.. The long rods support two mats up to 24" side-by-side. The narrow steel design with locking casters fits through all standard doorways. Assembly required. Black 54 1/2" L x 25 1/2" W x 48 1/2" H Ships direct from manufacturer
092538-DS



C



D

D. POWER SYSTEMS STANDING MAT RACK

The Standing Mat Rack is a Power Systems Brand product. The design makes it the perfect storage companion for the Power Systems Hanging Club Mats. The flexibility of the rack lets you place it wherever you want to keep your mats close by. The 10-inch prongs will hold up to 14 mats on each side. Ships direct from manufacturer.

092590-DS

A



A. POWER SYSTEMS QUICK CONE HURDLE SET

This hurdle set adds variety to foot-speed and agility drills. Cone height quickly adjusts to 3", 5", or 7"; wide base measures 11-1/2". Multiple set-up options let you create different patterns for developing quick foot lift and control. Set includes 12 pliable PVC cones, six 38" PVC crossbar units (12 crossbar components and 6 connectors require assembly), and a carry bag. Use indoors or outdoors.. Ships direct from manufacturer. 6 lbs
030280-DS

B



C



B. POWER SYSTEMS SLIDE BOARD

Improve power, change-of-direction, balance, agility, speed, flexibility, and endurance with lateral training. The Pro Slide Board is 8' long, rolls up for easy storage, and can be secured with a nylon strap to fit in a carry bag. Unit includes board made of high-density polyethylene with a nonskid backing and attached ramps, carry bag and one pair of standard booties. Use on any hard, flat surface. Ships direct from manufacturer 5 lbs
021161-DS

C. POWER SYSTEMS PRO SLIDE BOARD BOOTIES

Slide board booties fit mens sizes 5 - 12. Ships direct from manufacturer 0.25 lbs
021215-DS

D



D. POWER SYSTEMS AGILITY LADDER 30'

Develop rapid, precise foot strikes and focus. Fixed round rungs save set-up time and withstand abuse from cleats and other turf shoes. 30' ladders are comprised of two 15' sections. Ladders have PVC clips to connect to other units for a customized length; connect 2 or more end to end for intense agility ladder drills. Ladders can be used for both indoor and outdoor for a variety of agility drills. High-impact round PVC rungs. Includes carry bag. 30' L x 20" W ladder has 18 rungs. Ships direct from manufacturer
030694-DS

E



E. POWER SYSTEMS AGILITY LADDER 15'

All the benefits of the 30' Agility Ladder in a shorter version. Nine round, hard PVC rungs provide eight fixed stepping areas. Connect multiple 15' ladders for customized lengths. Includes carry bag. Use indoors or outdoors. Color: Black and yellow. Dimensions: 15' L x 20" W. Ships direct from manufacturer. 4 lbs
030692-DS



A. POWER SYSTEMS POWER PLYO BOX

These plyometric boxes provide maximum stability and durability with their steel construction and fully welded frames. Any athlete can use these boxes for forward jumps, lateral jumps, and other plyometric drills. Available in multiple heights for developing reaction time and overall explosiveness. Nonslip platform maximizes safety. Square tubular steel construction. Tops are reinforced 3/4" plywood with nonslip surface. Rubber bottoms protect floor. Stackable for easy storage. Use indoors or outdoors. Red/Black. Ships direct from manufacturer.

- 020505-AN-DS 12"
- 020505-BN-DS 18"
- 020505-CN-DS 24"
- 020505-DN-DS 30"
- 020505-EN-DS 36"

POWER PLYO BOX STARTER SET

Includes one each of the 12, 18, 24 and 30" boxes
020505-K1-DS



B. POWER SYSTEMS PREMIUM POWER PLYO BOX

With a stable square frame and a large landing area, this heavyweight plyo box is a solid choice for plyometric training for athletes of all sizes and abilities. The platform is covered with an extra-thick mat and the perimeter is rounded for added safety.

Square tubular steel construction. Tops are reinforced 3/4" plywood covered with 1/8" solid rubber mat. Stackable. Use indoors or outdoors. Black. 5-year limited warranty. Ships direct from manufacturer.

- 020601AN-DS 12"
- 020601BN-DS 18"
- 020601CN-DS 24"
- 020601DN-DS 30"
- 020601K1-DS Set of 1 each



C. POWER SYSTEMS FOAM PLYO BOX SET

If you are looking to customize the height of your plyo box, look no further, the Power Systems Foam Plyo Box set is where it is at! Each platform is covered with durable vinyl and can be stacked and secured with strong Velcro flaps on all four of the sides. Set includes one of each. 3", 6", 12", 18" and 24" platforms. Ships direct from manufacturer
020680-DS



D. POWER SYSTEMS ADJUSTABLE LATERAL PLYO BOX

Keep your opponent off balance. Highly durable platform trains explosive lateral movements for strong and quick direction changes. Quickly adjust sides of platform to 25", 35", or 45" to target all muscles of the ankle, leg, and hip. Reinforced nonslip platforms provide a stable and secure contact area. Each side holds a 45 lb. weight plate (sold separately). Square steel construction. Assembly required. Red/Black. 84" L x

18" Ships direct from manufacturer
010953-DS



E. POWER SYSTEMS MONSTER SLED

Ideal for training runs or coach-assisted runs, the Monster Sled features a 37" handle to accommodate wide and narrow grips as well as alternate grip positions. Sled comes with a padded shoulder harness for comfort with strong nylon leads. Two 12" weight posts hold up to 540 lbs. Strong welded steel. Assembly required. Instructions included. 50" L x 32" W x 2" H. Red. Ships direct from manufacturer.

010424-DS



F. TKO PRO PERFORMANCE BAG

The TKO Pro Performance bag is made with a durable 18oz vinyl shell and has a thick foam liner for comfort and to hold shape. The bag offers a unique enclosure to keep sand from escaping. Great for all levels of training.

The following Pro Performance bags measure 22 cm/55 cm (approximately 8 1/2" x 21 1/2")

- 0K250PB05-DS 5 kg / 11 lb
- 0K250PB10-DS 10 kg / 22 lbs
- 0K250PB15-DS 15 kg / 33 lbs

The following Pro Performance bags measure 25 cm x 60 cm (approximately 9 3/4" x 23 1/2")

- 0K250PB20-DS 20 kg / 44 lbs
- 0K250PB25-DS 25 kg / 55 lbs
- 0K250PB30-DS 30 kg / 66 lbs
- 0K250PB35-DS 35 kg / 77 lbs

PERSONAL TRAINING - CARDIO / AGILITY



A. BUDDY LEE JUMP ROPE

The Buddy Lee jump rope was developed by Olympian Buddy Lee. Lee is a former olympic wrestler and jump rope master. This precision jump rope will provide the perfect cardio workout for all users.

TRXJUMP-DS

B. 9' ADJUSTABLE JUMP ROPE

The speed jump rope has black handle grips and an adjustable 9' rope. 1/2 lb 0HHR001

POWER SYSTEMS POWEROPES

The PoweRope has the weight evenly distributed throughout a solid rubber rope. Handles have ball-and-socket swivel to make for a quick rotation. Ships direct from manufacturer

- C. 035501-DS 1 lb Red
- D. 035502-DS 2 lb Blue
- E. 035503-DS 3 lb Green
- F. 035504-DS 4 lb Orange

G. POWER SYSTEMS VINYL JUMP ROPE

Jump rope training is easy, intuitive, and fun, all while providing a number of benefits. Because there are a vast variety of rope skipping styles, your clients can easily modify their workout to help them reach specific goals. Speed jump rope training helps athletes improve agility, strength, and endurance, which leads to higher performance on the field. Training with a jump rope for heart health can be an enjoyable way for people who are new to fitness to get involved with a training program. Ships direct from manufacturer

- 035058-DS 8' Red.
- 035059-DS 9' Blue
- 035060-DS 10' Black



H. POWER SYSTEMS ANKLE / WRIST WEIGHTS

The unique design of these soft, fabric-covered weights make them suitable for wearing around the ankle or on the wrist. Velcro closure. Ships direct from manufacturer

- 09060101BK-DS 2 lb pair, 1 lb per ankle Black
- 0906012HBK-DS 5 lb pair, 2.5 lbs per ankle, Black
- 09060105BK-DS 10 lb pair, 5 lbs per ankle, Black

I. POWER SYSTEMS PREMIUM ANKLE WEIGHTS

Weight adjustable! Add or remove weight without taking them off. These ankle weights have external pockets, so you can adjust the weight to suit your needs. Adjustable Velcro closures ensure a secure fit. One size fits most. Removable weights included. Ships direct from manufacturer.

- 09057105-DS 5 lb pair, 2.5 lbs per ankle
- 09057110-DS 10 lb pair, 5 lbs per ankle
- 09057115-DS 20 lb pair, 10 lbs per ankle
- 09057120-DS 20 lb single weight



POWER SYSTEMS AIROPE

From beginner to advanced, individuals at all skill levels can improve their cardiovascular conditioning by using the Airopo. Incorporate it into group fitness classes, sports performance training, or rehabilitation, or simply perform traditional jump rope actions without the hindrance of a rope. The Airopo will intensify any exercise. Use it alone or combine it with other equipment for greater versatility. There are no limits to what you can do, and getting started is as simple as the turn of the handles. The rope on the Airopo PRO is thicker providing more rotational resistance than the Airopo Original. Instructions included. Solid rubber weighted rope; padded PVC handles. Ships direct from manufacturer. 20" L.

- J. 034900GR-DS Original
- K. 034900RD-DS Pro

L. VERSA FIT LOG

The Versa Fit Log allows you to train in many different ways. From balance and plyometric to rotational and Olympic lifts. The Versa Fit Log comes with 6 handles for various gripping locations. Versa Fit Log measures 23" L x 8" in diameter. Available from 10-50 lbs in 10 lb increments.

- 013481-DS 10 lb log
- 013482-DS 20 lb log
- 013483-DS 30 lb log
- 013484-DS 40 lb log
- 013485-DS 50 lb log





PERSONAL TRAINING - BALANCE



POWER SYSTEMS CLOSED CELL FOAM ROLLER

This closed-cell foam roller provides consistent pressure to massage your muscles and improve your posture and alignment. Pilates, yoga, rehabilitation and many other exercises can be enhanced with the addition of foam rollers. Use them to help develop balance, postural alignment, and flexibility or as support for dynamic strength exercises. Ships direct from manufacturer

A 080200-DS 12" x 6" Roller

B 080225-DS 18" x 6" Roller

C 080220-DS 36" x 6" Roller



D. POWER SYSTEMS PREMIUM EVA FOAM ROLLER

Power Systems foam rollers have been used for years not only by professional athletes and physical therapists to release tight muscles and trigger points, but by people at all fitness levels to help make their workouts more effective. The high quality of EVA closed-cell polyethylene foam allows for excellent durable support while being soft on the skin. Lower quality foam rollers are likely to lose their shape when exposed to humidity and frequent use. Your Power Systems EVA foam roller is designed for heavy use, and will maintain its shape and firmness far longer. Roller measures 36" x 6" Round. Ships direct from manufacturer **080260-DS**



POWER SYSTEMS HIGH DENSITY FOAM ROLLERS

This firm, high-density molded foam roller provides a deeper massage during usage. The closed-cell construction lasts up to 5 times longer than open-cell foam rollers. Select round for traditional massage and alignment and half round for balance and stabilization. Made in USA. Ships direct from manufacturer. Additional shipping cost may apply.

E. 080231-DS 36" Half Round

F. 080232-DS 36" Round

G. 080237-DS 18" Round

H. 080233-DS 12" Round

I. 080234-DS 12" Half Round

J. POWER SYSTEMS VERSA BALANCE LOG

2 balance options! Use this half-round log with the flat side down for a more stable training surface and the rounded side down for more unstable activities. Durable EVA foam construction provides firm support. Textured surface prevents slipping. Do not stand on while wearing shoes. Blue. Ships direct from manufacturer.

081017-DS



K. POWER SYSTEMS STUDIO FOAM ROLLER CART

The perfect foam roller storage solution for the small studio or club. Includes casters so cart can be easily moved. Gray steel tubular construction with casters included. Holds up to 12 6" diam. foam rollers. Ships direct from manufacturer

080186-DS



L. POWER SYSTEMS ECONOMY FOAM ROLLER WALL RACK

A simple and cost effective way to store your foam rollers. This easy to assemble, easy to mount black rack provides storage capabilities that will keep your gym looking clean and your foam rollers lasting longer. This rack holds up to 6 foam rollers and you can remove unused sections of the rack if less space is needed. Foam rollers are not included. Holds up to 6 foam rollers. Ships direct from manufacturer. 24" W x 47-1/2" H x 9" deep

080241-DS

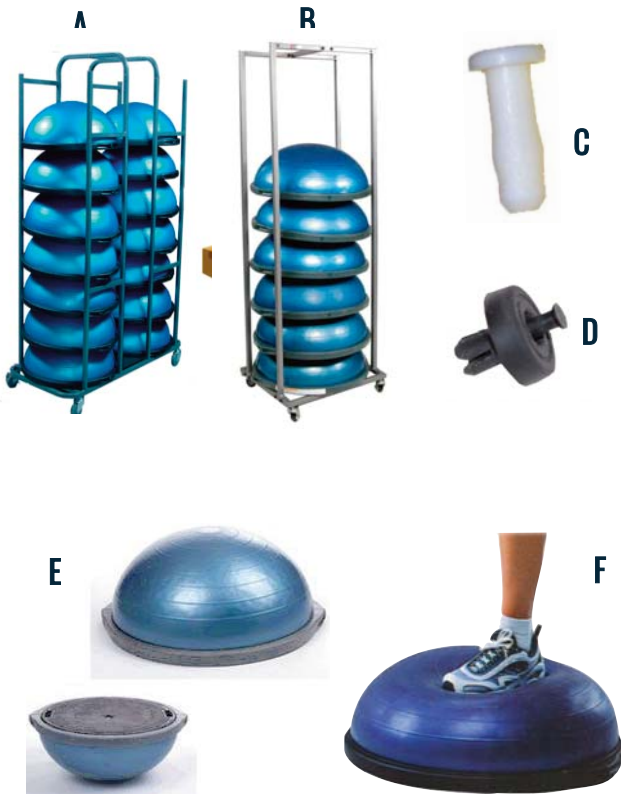

A. BOSU BALL STORAGE RACK

The convenient Bosu® storage rack allows you to keep your area neat and clean without taking up a lot of space. The rack is made of welded steel tubing with a gray powder coated finish and wheels for mobility. The rack holds up to 14 Bosu® Balls and measures 49.5" long x 25" wide and 76" high. Ships direct from manufacturer. 60 lbs
010874-DS

B. POWER SYSTEMS SMALL BOSU BALL STORAGE RACK

Small Storage Rack for BOSU stores up to 6 Pro Balance Trainers .
070293-DS

C. BOSU BALL PLUG

0108502P

D. RUBBER FEET

Replacement feet for Bosu Ball. 6 per pack. 1 lb
0108502R

E. BOSU BALL PRO

Featuring a new, improved design and durability, the BOSU® PRO Balance Trainer has a bladder weight of 8 pounds, and a dually over-molded platform for extra strength. It has a smooth, non-skid, non-marking base. The BOSU® PRO Balance Trainer has a blue dome, light grey clamp and platform, and includes a foot pump, BOSU® Integrated Balance Training Manual and DVD. Ships direct from manufacturer. 19 lbs
010850PRO-DS

F. BOSU BALL

This is the ultimate in core stabilization, balance and body awareness training. The unique half-circle inflatable ball makes it a versatile exercise training device. Its shape provides multiple applications for sitting and standing. Can be used ball side up or platform side up. Platform measures 25" in diameter and 12" high Includes hand pump and instructional guide. Ships direct from manufacturer. 17 lbs

FREE SHIPPING

0108502Q-DS



G. POWER SYSTEMS STEP360 PRO

The Step360 Pro is a great tool to add to your balance and stability training. You can adjust the air in each chamber to fit your level of balance. The top deck has a non-slip surface and 6 slots for introducing tubing into your stability workout. Comes with a hand pump. Ships from manufacturer. 21 lbs
078500-DS



H. POWER SYSTEMS WOBBLE & ROCKER BOARD

Stand, sit or kneel! The Rocker Board moves in one directional plane and has a large square design for beginners. The Wobble Boards move in multiple planes and have a smaller round design for intermediate and advanced users. Both Wobble Boards offer 3 levels of difficulty and adjusts in seconds. Boards feature birch wood construction and slip resistant tops. Ships direct from manufacturer

Beginner - 20" Rocker Board with up to a 14 degree angle.
80350-DS

Intermediate - 20" Wobble Board Adjustable with 10, 12 and 15 degree angles.
080360-DS

Advanced - 16" Wobble Board, adjustable with 15, 17 or 20 degree angles.
080370-DS

Set of 3 - Includes 1 each beginner, intermediate and advanced
080355-DS



I. BALANCE BLOCK

This durable and easy to clean block is great for rehabilitation and balance training. Available in blue. 2.5" x 16" x 19" 3 lbs
033101



J. POWER SYSTEMS VERSA DISC

Build strength by using this 13-1/2" diameter air-filled disc when doing balance-based exercises. Enhance balance and functional training by incorporating 2 discs. The bottom of the VersaDisc has small nodules for use in rehabilitation and massage therapy; also keeps disc from moving during exercise. Soft PVC. 13-1/2" diam. x 3" H. 3 lbs. Ships partially inflated, however some users may need to adjust the inflation level. Maximum inflation is 4" high. Ships direct from manufacturer. 3 lbs

080167-RE-DS

A



B



C



D



E



F



G



H



A. DYNA BANDS

Dyna Bands which are made from natural latex rubber can be used to tone and strengthen all the major muscle groups. Ships direct from manufacturer.

0NPKH08-DS	Light	Pink, 75 ft roll	Not Available
0NGNB12-DS	Medium	Green, 150 ft roll	Not Available
0NGNH12-DS	Medium	Green, 75 ft roll	Not Available
0NPUB16-DS	Heavy	Purple, 150 ft roll	Not Available
0NPUH16-DS	Heavy	Purple, 75 ft roll	Not Available

B. POWER SYSTEMS STRENGTH BAND

Resistance bands attach to weight bars and benches for added resistance during lifts. Effective for stretching the upper and lower body as well. Width of band determines resistance. The greater the stretching distance of the band, the greater the resistance load. Packable and portable. Seamless latex rubber constructed in layers to prevent breakage. Ships direct from manufacturer. All bands are 41" L.

068162-DS	Extra Light - Orange
068163-DS	Light - Red
068164-DS	Medium - Black
068161-MD-DS	Heavy - Purple
068161-SE-DS	Extra Heavy - Green
068161-LG-DS	Ultra Heavy - Blue
068168-DS	Super Heavy - Black

D. POWER SYSTEMS PREMIUM VERSA TUBE

Perform strength and fitness exercises with the Premium Versa-tube tubing through a full range of motion. Resistance tubing is available in multiple resistance levels to accommodate all your fitness needs. Nylon handles with premium padded grips. Ships direct from manufacturer.

084000-DS	Orange - Extra Light
084005-DS	Green - Light
084010-DS	Red - Medium
084015-DS	Blue - Heavy
084020-DS	Purple - Extra Heavy
084022-DS	Gray - Ultra Heavy

POWER SYSTEMS VERSA TUBE KIT (not pictured)

Kit includes 6 Versa Tubes, 1 of each level of resistance listed on letter D above.

099960-DS	Versa Tube Kit
------------------	----------------

F. POWER SYSTEMS VERSA CUFF

The perfect exercise tool to tone and strengthen the muscles of the lower body. New double-lock system ensures tubing remains intact while performing multi-directional movements. 12" length. Ships direct from manufacturer.

084300-DS	Orange - Extra Light
084305-DS	Green - Light
084310-DS	Red - Medium
084315-DS	Blue - Heavy
084320-DS	Purple - Extra Heavy
084322-DS	Gray - Ultra Heavy

H. POWER SYSTEMS WALL MOUNTED STORAGE RACK

Stores 140 standard jump ropes on 4 posts. Bolts to wall (mounting hardware not included). Perfect for storing resistance tubes, jump ropes or weight belts. Resistance tubes sold separately. 10 lbs

068160-DS

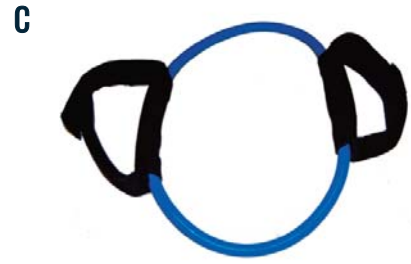

A. THE ORIGINAL XERTUBE™

The patented Xertube™ offers progressive resistance levels for multiple uses and fitness levels. Allows for isolation of targeted muscle groups and full range of motion exercise. Ideal for group exercise and traveling. Ships direct from manufacturer. 1/2 lb

- 0XT-VL-DS** Yellow - Very Light 44" long
- 0XT-L-DS** Green - Light, 44" long
- 0XT-M-DS** Red - Medium, 50" long
- 0XT-H-DS** Blue - Heavy, 53" long
- 0XT-UHP-DS** Purple - Ultra Heavy, 53" long

B. ULTRA TONER®

The patented Ultra Toner offers resistance levels to give you the results you're looking for. Excellent for total upper body conditioning. Includes one instruction sheet per order. 1 lb

- 0UT-VL-DS** Yellow - Very Light
- 0UT-L-DS** Green - Light
- 0UT-M-DS** Red - Medium
- 0UT-H-DS** Blue - Heavy
- 0UT-UHP-DS** Purple - Ultra Heavy

C. XERCUFF®

Xercuffs measure 32" long and are designed for full range of motion movement drills and exercises to target lower body conditioning. The padded cuffs are large to accommodate all body types. 1 lb

- 0XRC-VL-DS** Yellow - Very Light
- 0XRC-L-DS** Green - Light
- 0XRC-M-DS** Red - Medium
- 0XRC-H-DS** Blue - Heavy

D. XERING®

The Xering® will shape your legs and improve overall lower body muscle tone. Includes rubber grips for added comfort.

- 0AR-VL-DS** Yellow - Very Light
- 0AR-L-DS** Green - Light
- 0AR-M-DS** Red - Medium
- 0AR-H-DS** Blue - Heavy
- 0AR-UPH-DS** Purple - Ultra Heavy

E. POWER SYSTEMS VERSA-LOOP

If you or your client are looking for something new to add to a workout, or your needs aren't met by the most popular forms of gym equipment, Power Systems Versa Loops resistance bands might be a good choice. These are a cost-effective way to get a whole body workout, making them a popular choice. The six different colors each provide a different level of resistance. They're useful for a huge variety of exercises that target the legs, core, arms, and back. 12" diameter. Ships direct from manufacturer.

- 084801-DS** Extra Light - Orange
- 084890-DS** Extra Light - Orange, 10 pack
- 084806-DS** Light - Green
- 084891-DS** Light - Green, 10 pack
- 084810-DS** Medium - Red
- 084892-DS** Medium - Red, 10 pack
- 084816-DS** Heavy - Blue
- 084893-DS** Heavy - Blue, 10 pack
- 084823-DS** Extra Heavy - Purple
- 084894-DS** Extra Heavy - Purple, 10 pack
- 084821-DS** Ultra Heavy - Gray
- 084895-DS** Ultra Heavy - Gray, 10 pack
- 099974-DS** Versa Loop Kit

F. POWER SYSTEMS MINI VERSA LOOP

Versa Loops in a size better suited for upper body exercises or use on recumbent bikes. Versa Loops are perfect for personal training and for use in fitness clubs and home gyms. Six resistance levels for any user, whether you are an experienced athlete or just beginning fitness training. Ideal for short, limited arm movements. Fits comfortably around the wrist or forearms. 9" diameter. Ships direct from manufacturer.

- 084933-DS** Extra Light- orange, 10 pack
- 084934-DS** Light - Green, 10 pack
- 084935-DS** Medium - Red, 10 pack
- 084936-DS** Heavy - Blue, 10 pack
- 084937-DS** Extra Heavy - Purple, 10 pack
- 084938-DS** Ultra Heavy - Black, 10 pack

PERSONAL TRAINING

A



B



A. HEAVY DUTY WRIST EXERCISER

Heavy duty design features a nylon webbing strap for maximum strength and a one piece plate holder that will fit both standard and Olympic plates. 2 lbs
OMATB409HD

B. WRIST EXERCISER

Includes reinforced nylon cord for maximum strength and a two piece plate holding system for added security. Fits both standard and Olympic plates. 1.5 lbs
OMATB409

G. PUSH UP BARS

Increases strength and range of motion. Alleviates stress on wrists and hands. Hollow. 2.5 lbs
OHHP001



D



D. POWER SYSTEMS CORE ROLLER

Build firmer and stronger abs with the Core Roller. This roller has an extra wide single wheel with ergonomic handles that let you perform roll-outs, inch worms, side-to-side roll work, and rolling planks. Assembly is required. 2.5 lbs
092446-DS

E



E. READING RACK

Made of 1/8" PETG plastic. Making it durable as well as lighter and thinner than most other racks. Our rack is has two size lips so it fits almost every brand of equipment. Measures 11" wide, 10" tall with one 2 1/2" deep lip and one 3" lip.

ORR 1
6 - 11
12 or more

F



G



TKO WEIGHTED VEST

TKO Weighted Vest will add a different feel to any workout. Ideal for strengthening legs and overall body toning. Vest is constructed with a tough synthetic vest and has stretch pockets for the weights.

F. 0242WV-DS 20 lb Vest
G.0244WV-DS 40 lb Vest

H. POWER SYSTEMS INFINITY VEST

Designed to improve your speed, strength and overall fitness, the comfortable form-fitting Infinity Vest adds resistance to your body-weight training, jogging, jumping or other fitness activities without hindering movement. This weighted workout vest is made of breathable material for comfort and quick release buckles for convenience

H. 013242-DS 6 lb Blue
I. 013244-DS 10 lb Black



J. POWER SYSTEMS VERSA VEST

Use weighted clothing such as the VersaFit Vest by Power Systems to increase strength and efficiency during your speed, power and agility drills. By adding weighted clothes to your workout, you can experience a unique fitness training effect that you can't get from traditional free weight fitness gear. Padded nylon vest comes with removable sand-filled weight bags. Easily customizable for any workout.

013227-DS 10 lbsVest Includes ten 1 lb. weights, fits 28" - 48" chest
013228-DS 20 lbsVest includes twenty 1 lb. weights, fits 32" - 56" chest
013229-DS 40 lbs vest includes twenty 2 lb. weights, fits 34" - 62" chest

POWER SYSTEMS POWER TRAINING ROPES

Nothing works the body for developing power and explosiveness quite like rope training. Various lengths and diameters push your stamina, grip strength and overall conditioning like no other. Find out what all of the excitement is about. Start rope training! 1.5" diameter and 2" diameter. All items below ship direct from manufacturer.

K. POWER SYSTEMS BLACK ROPE 1 1/2" DIAMETER

013646-DS 50' long 27 lbs
013644-DS 40' long 22 lbs
013642-DS 30' long 16 lbs

POWER SYSTEMS BLACK ROPE 2" DIAMETER

013656-DS 50' long 27 lbs
013654-DS 40' long 22 lbs
013652-DS 30' long 16 lbs

POWER SYSTEMS ROPE ACCESSORIES

L. 013690-DS Rope Anchor
M.013688-DS Rope Hanger

N. POWER SYSTEMS BATTLE ROPE ANCHOR STATION

Take your group training sessions to the next level with Power Systems Battle Rope Anchor Station. Anchors up to 12 battle ropes for the ultimate group training experience. Center area is built to fit any Olympic plate for extra security. 24" L x 24" W x 11-1/2" H
013692-DS

K



L



M



N



SUSPENSION TRAINING / CROSSCORE



A. POWER SYSTEMS TRAINING RING

They're not just for gymnasts! One of the hottest pieces of alternative training equipment is the Training Rings. Challenge your fitness level and your body weight training like never before. Perform pull-ups, rows, muscle-ups and other suspended exercises on the independently hanging rings. This unstable environment will call in muscles to assist in almost every exercise. Includes (2) easy-to-grip durable ABS material rings, Ring thickness: 1-1/8"; Ring Diameter: 7-1/8" inside dia., 9-3/8" outside dia.; (2) 1Wx14" straps with 2 heavy duty secure buckles. Ships direct from manufacturer. 4 lbs

093896-DS

C. POWER SYSTEMS PRO ABDOMINATOR

Develop the muscles of the core by performing hanging leg raises with a pair of these extra-wide 8" padded arm straps. They support the body comfortably, so you can perform lots of reps. Aluminum carabiners attach quickly and easily to any sturdy overhead bar up to 1-1/4" diam. Supports up to 300 lbs. Black. Ships direct from manufacturer. 2 lbs

067112-DS

D. 7 1/2" PROFESSIONAL AB SLING

Use for toning, trimming and conditioning of the entire abdominal area without lower back strain. The Professional Ab Slings help to stretch muscles and decompress the spine. Slings are 7 1/2" wide with a soft fabric lining and heavy solid steel locking carabiners. 300 lb capacity 4 lbs

OHHDFS001



E. CROSSCORE 180 COMPLETE ROTATIONAL BODY WEIGHT TRAINING SYSTEM

CrossCore180® Rotational Body Weight Training System™ adds rotation to any body weight training routine and allows sports specific movements and programs to be designed by coaches for their athletes. CrossCore180® is the perfect training tool for coaches, athletes, group training and rehabilitation. Challenge yourself. PULL THE PIN! Locked-N-Loaded deactivates the pulley rotation and stabilizes the handles for exercising without the pulley. PULL THE PIN and the CrossCore180® turns any workout into a rotational, multi-planar body assault.

System includes: (1) CrossCore180® complete Rotational Bodyweight Training System™ (includes training manual and training DVD) (1) Door anchor (1) Heavy Duty canvas carrying bag

CrossCore® Heavy-Duty Specs: Commercial "Heavy-Duty" Construction, Climbing rope rated to hold up to 1,200 lbs., Heavy-Duty climbing carabiners are rated to hold up to 5,000 lbs., Adjustable cam buckle strap is rated to hold up to 1,800 lbs., Handle webbing is rated to hold up to 2,100 lbs., Pulley wheel includes high quality sealed bearings for long lasting smooth rotation, Fully powder coated pulley housing. Ships direct from manufacturer. 6 lbs

CC001-DS

F. CROSSCORE NYLON KETTLEBELL/RING STRAP WITH STEEL D-RING

Can be used to attach a Kettlebell or dumbbell on one side of your CrossCore180® for exercise routines using a counterweight or be used for connecting gymnastics rings in place of handles. Includes one pair of Kettlebell/Ring straps only. Limited One Year Warranty. Ships direct from manufacturer. 1 lb

Kettlebells, Dumbbells and Rings not included in this purchase.

CC003-DS

G. CROSSCORE CEILING / WALL ANCHOR

Great for creating an anchor point from a ceiling beam or wall beam when nothing else is available. Base is made from 3/4" steel plate and measures 4" x 5.5". Includes four bolt holes for better versatility when mounting and (2) 3/8" x 3.5" lag screws and (2) washers). Use for wood only. Always read the included Ceiling/Wall Anchor instructions BEFORE using. Professional installation recommended. Ships direct from manufacturer.

CC002-DS

H. CROSSCORE GYMNASTICS RINGS WITH STRAPS AND STEEL D-RING

Gymnastics rings can be used to add rotation to classic ring exercises such as dips, presses and muscle-ups. Rings attach easily to your CrossCore180® via the Ring Straps. Heavy duty plastic rings have a break strength of 4,500 lbs. per ring. Diameter is 8" which is the same diameter as gymnastics regulation rings. Includes one pair of Gymnastics Rings with straps. Limited One Year Warranty. Ships direct from manufacturer. 4lb

CC004-DS



A. POWER SYSTEMS BAR FLOAT

This 25" Bar Float features triple floats at each end. Provides stable, secure buoyancy for added support and resistance. Not adjustable. Blue. 25". Ships direct from manufacturer.

086590-DS

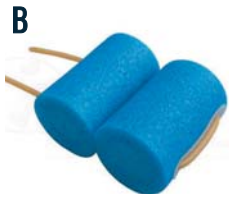

G. 4" x 6" PULL BUOY

The 4" x 6" Pull Buoy is ideal for all types of swim training and water exercises. The two floats are adjustable.

OK0305

PULL BUOY

Focus on your upper body and change up your lap routine! Pull Buoys are a swim training aid. When isolating the upper-body as part of a water exercise routine or as equipment for a swimming workout, Pull Buoys are placed between the legs to provide flotation, without kicking. The two Floats are woven together by a yellow, sturdy, adjustable strap that allows the user to adjust the distance between the two Floats. Each Pull Buoy is constructed of closed-cell polyethylene foam that is latex-free, and does not absorb moisture.

C. PULLBUOY4X6CASE16-DS 4" x 6", case of 16

D. PULLBUOY4X7CASE16-DS 4" x 7", case of 16

E. PULLBUOY4X8CASE12-DS 4" x 8", case of 12

F. POWER SYSTEMS WATER DUMBBELLS

Designed like traditional dumbbells, the aquatic version has one, two and three round floats on each end, depending on the resistance level. Hand grips are cushioned for comfort. Unlike traditional free weights, water dumbbells are light and portable when out of the water. Made of EVA foam for durability, they are UV, bacterial and water resistant for hygiene and are incredibly fast drying. Sold in pairs. Blue.

086550-DS Light (pair)

086560-DS Medium (pair)

086570-DS Heavy (pair)



G. HAND BUOY

Comfort straps keep these weights on your hands without extra effort on your part. Perfect for persons with arthritis, carpal tunnel, or TOS. These specially-designed hand buoys are easily gripped due to the comfort straps that keep the Buoy from floating away. Perfect for arthritic hands or persons with carpal tunnel. White polyethylene foam logs are equipped with a 1 inch-wide adjustable strap to comfortably keep the buoy on your hands. One size fits all - perfectly!

HANDBUOY3X12CS15-DS Case with 15 pair

H. KICK BAR

Kick bars are excellent tools to add to your aquatic routine. By holding the handles, the flotation discs in the middle provide a pivot point, allowing you to work your back and abdominal muscles while kicking or floating. Bar Length is 31" Diameter of float 6"

KICKBARCASE12-DS Case of 12

I. WATER LOG

Water logs have a 3" diameter Provides deep water buoyancy and shallow water stability.

Water Logs are available in quantities smaller than 12.

WATERLOG60X3CS12-DS Case of 12

AEROBICS / GROUP EXERCISE - STEPS

A



A. REEBOK PROFESSIONAL AEROBIC STEP

Introduced to health clubs over 25 years ago, the timeless aerobic Reebok step remains an integral and immensely popular piece of equipment in the group fitness exercise arena today. This is your platform to perform a large range of basic and more complex exercises from cardiovascular and plyometric training to lower body muscle toning; its versatility is ideal for mixing up any workout program. Sturdy and durable for every lunge and jump, the Reebok step's non-slip rubber surface means you can focus on your form and positioning, plus it can be height adjusted in three increments (6, 8 or 10 in) for added Intensity. The work-out surface of 39 x 15 in is large enough for fitness activities, but at the same time the step is compact and easy to store away at home when your workout is complete - convenient and completely hassle free. Fitness trends will change, but the Reebok step is the trusted workout accessory that stands the test of time. Price includes shipping.

ORESTEP-DS

B



B. TKO FITNESS STEP

The TKO Fitness Step is adjustable 4", 6" or 8" heights and has a ribbed mat for better traction. Ideal for any fitness class, home or personal trainers. Set comes with platform and 4 risers. 40 lbs
0275FS

C



D



THE STEP™

The Original Club Step is made from stable polyethylene for durability and long life. It has a non-slip, shock absorbing ribbed platform top for safety and non-skid rubber disks on the risers for traction and stability. Ships direct from manufacturer. 21 lbs.

C. 0F1005W-DS Teal top with purple risers

D. 0F1011W-DS Gray top with black risers

BUY A PACK OF 10 STEPS WITH RISERS AND SAVE

0F1005W10-DS Teal top with purple risers

E



ORIGINAL HEALTH CLUB STEP RISERS ONLY

Set of 2 blocks for use with The Step® "Original Health Club" Step. These blocks accommodate step surfaces that measure 14" x 40" Supports up to 200 lbs. Available in violet or black. Ships direct from manufacturer.

E. 0F1104W-DS Set of 2 Purple Risers

0F1105W-DS Set of 20 Purple Risers

F. 0F1108W-DS Set of 2 Black Risers

0F1109W-DS Set of 20 Black Risers

F



ORIGINAL HEALTH CLUB STEP PLATFORM ONLY

0F1107W-DS 5 Grey Platform

G



G. REEBOK STEP CLIP

Replacement Clip for the Reebok Step

0226502 Priced per clip

0226502-50 Pack of 50 clips

0226502-100 Pack of 100 clips

A



A. TROY BARBELL WEIGHTED BARS

Troy Barbell's weighted bars feature a solid steel core for evenly distributed weight and covered in soft black foam for durability and comfort. The ends of the bar are covered in a color-coded rubber end cap with the weight of the bar. Perfect for sit-ups, squats, lunges and upper body exercises. Ships direct from manufacturer.

- 0GTB004-DS 4 lb
- 0GTB006-DS 6 lb
- 0GTB009-DS 9 lb
- 0GTB012-DS 12 lb
- 0GTB015-DS 15 lb
- 0GTB018-DS 18 lb
- 0GTB022-DS 22 lb
- 0GTB027-DS 27 lb

B

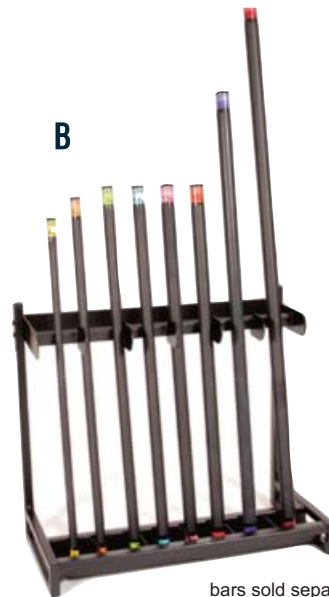

bars sold separately

B. TROY BARBELL WEIGHTED BAR RACK

Stores weighted bars for easy access. Holds up to 24 bars. Some assembly required. Black. Ships direct from manufacturer. 36" x 20" x 33" 45 lbs
0GTBR24

C



C. BODY BARS®

These bars are encased in a comfortable, durable black rubber sleeve and have color-coded end caps. They are ideal for weight training programs to build lean body mass and muscle definition. 4' long. Ships direct from manufacturer.

- | | |
|---------------------|---------------------|
| 0BAR03-DS 3 lb bar | 0BAR15-DS 15 lb bar |
| 0BAR04-DS 4 lb bar | 0BAR18-DS 18 lb bar |
| 0BAR06-DS 6 lb bar | 0BAR24-DS 24 lb bar |
| 0BAR09-DS 9 lb bar | 0BAR30-DS 30 lb bar |
| 0BAR12-DS 12 lb bar | 0BAR36-DS 36 lb bar |

bars sold separately

D



E



D. BODY BAR RACK

30 Bar storage rack, 24" W x 33" H x 18" D, Ships direct from manufacturer. 47 lbs
0BSR28-DS

MINI BODY BARS (not pictured)

Shorter versions of the Body Bar. Solid steel construction. Rubber end caps. Measure 2' long. ships Direct from manufacturer.

- 0BARM04-DS 4 lb Bar
- 0BARM06-DS 6 lb Bar
- 0BARM09-DS 9 lb Bar

E. MINI BODY BAR RACK

Holds Up to 30 Mini Body Bars. 22"x24"x12"
0MR1-DS

FITNESS CHARTS

All fitness charts are full color and laminated for durability.

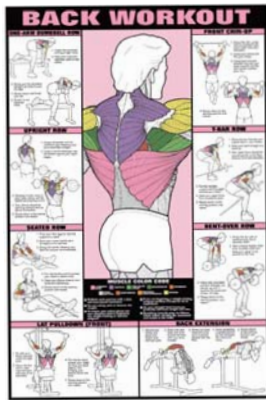

A

A. BACK WORKOUT

The Back Workout Fitness Chart shows you the correct way to do eight strengthening exercises for upper, middle and lower back.

0CHNFC3B 24" x 36"
0CHNFC3E 11" x 16"



B

B. CHEST WORKOUT

The Chest Workout Fitness Chart shows you free-weight & resistive exercises to strengthen chest muscles.

0CHNFC4B 24" x 36"
0CHNFC4E 11" x 16"

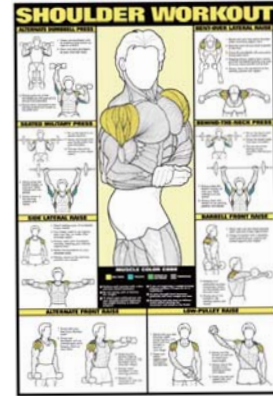

C

C. SHOULDER WORKOUT

Eight exercises for strengthening the shoulder muscles.

0CHNFC5B 24" x 36"
0CHNFC5E 11" x 16"

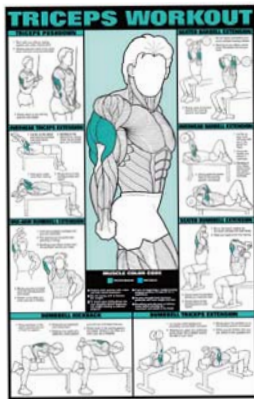

D

D. TRICEPS WORKOUT

Eight free weight and machine exercises for strengthening the tricep muscles.

0CHNFC6B 24" x 36"
0CHNFC6E 11" x 16"



E

E. ABDOMINAL WORKOUT

The Abdominal Workout Fitness Chart features eight exercises to strengthen the abdominal muscles.

0CHNFC8B 24" x 36"
0CHNFC8E 11" x 16"



F

F. EXERCISE STRETCHES

Illustrates 10 different stretches for before and after exercise.

0CHNFC11B 24" x 36"
0CHNFC11E 11" x 16"



G

H

G. DUMBBELL WORKOUT - CHEST, BICEPS, TRICEPS & FOREARM

Shows 10 dumbbell exercises to work your chest, bicep, tricep and forearm muscles.

0CHNFC12B 24" x 36"
0CHNFC12E 11" x 16"

H. DUMBBELL WORKOUT - SHOULDER, BACK, LEG & CALF

Shows 10 dumbbell exercises to work your shoulders, back, leg and calf muscles.

0CHNFC13B 24" x 36"
0CHNFC13E 11" x 16"

FITNESS CHARTS

A

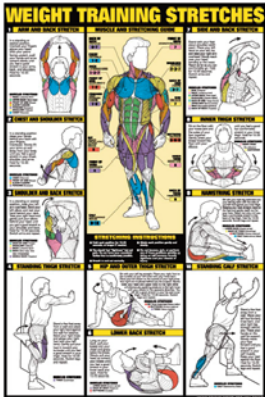

B

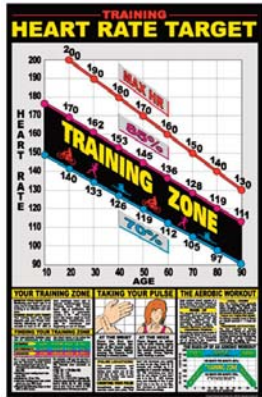

C

AGE	55%	60%	70%	80%	85%
15	19	21	24	27	29
20	18	20	23	27	28
25	18	19	23	26	28
30	17	19	22	25	27
35	17	19	22	25	26
40	17	18	21	24	26
45	16	18	20	23	25
50	16	17	20	23	24
55	15	17	19	22	23
60	15	16	19	21	23
65	14	16	18	21	22
70	14	15	18	20	21
75	13	15	17	19	21
80	13	14	16	19	20
85	12	14	16	18	19
90	11	13	15	17	18

A. WEIGHT TRAINING STRETCHES

The Weight Training Stretches Fitness Chart is a must have for your stretching area. It shows the proper way to do 10 different stretches.

0CHNFC10B 24" x 36"

0CHNFC10E 11" x 16"

B. TRAINING HEART RATE TARGET

Self-instructional guide for improving cardiovascular performances.

0CHF12B 24" x 36"

0CHF12E 11" x 16"

C. 10 SECOND HEART RATE

The Ten Second Heart Rate poster is designed to display the target heart rate needed to successfully achieve your fitness goals. This poster is a great addition to any health or fitness facility.

0CHF15B 24" X 36"

0CHF15E 11" x 15"

D

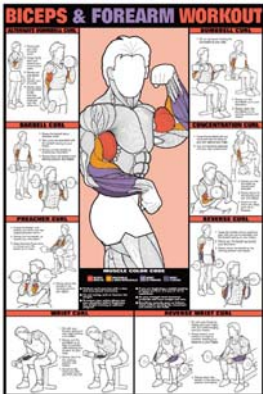

E

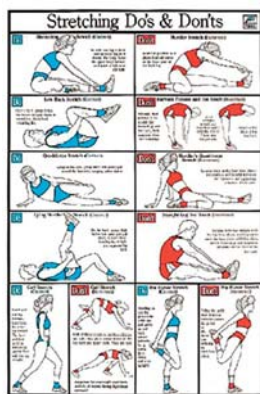

F



D. BICEPS & FOREARM WORK OUT

The Abdominal Workout Fitness Chart features eight exercises to strengthen the abdominal muscles.

0CHNFC9B 24" x 36"

0CHNFC1E 11" x 16"

E. STRETCHING DO'S & DON'TS

A must have for your stretching area.

0CHF18B 24" x 36"

0CHF18E 11" x 16"

F. EXERCISE DO'S & DON'TS

A must have for your stretching area.

0CHF17B 24" x 36"

0CHF17E 11" x 16"

G

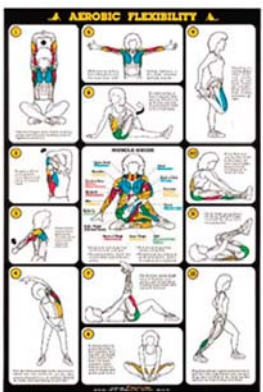

H



I



G. AEROBIC FLEXIBILITY

12 before and after strengthening exercises.

0CHF14B 24" X 36"

0CHF14E 11" X 16"

H. DUMBBELL EXERCISES - SHOULDER & ARMS

Full color poster features 22 dumbbell exercises for working the shoulders, rotator cuff, triceps, biceps and forearms. 24" x 36" laminated. 2 lbs

0PPFDESA

I. DUMBBELL EXERCISES - LOWER BODY / CORE, CHEST & BACK

18 dumbbell exercises for working the core (abs, lower back, chest, back and legs. 24" x 36" laminated. 2 lbs

0PPFDELB

A



A. BEGINNING YOGA POSTER

Poster illustrates and describes thirteen basic yoga poses. 24" X 36", 2 lb 0CHF26B

B



B. BODY BALL EXERCISE - CORE

15 ball exercises to work your ab's and lower back. 24" x 36" laminated. 2 lbs 0PFPBBC

C

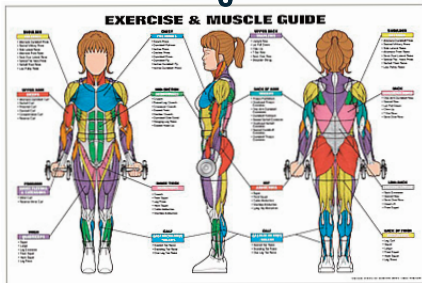

C. EXERCISE AND MUSCLE GUIDE - FEMALE

Labeled female muscular system with aerobic weight & floor exercises to shape and tone.

0CHNFC2B 24" x 36"
0CHNFC2E 11" x 16"

D

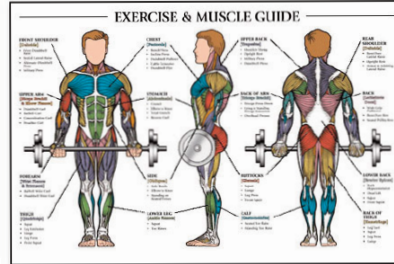

D. EXERCISE AND MUSCLE GUIDE - MALE

Labeled male muscular system with weight and resistive exercises to shape and develop.

0CHNFC1B 24" x 36"
0CHNFC1E 11" x 16"

E

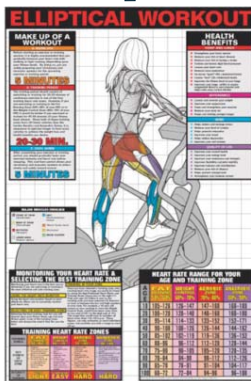

E. ELLIPTICAL WORKOUT

Detailing the muscles involved while using the Elliptical. The chart is 24" x 36" and is laminated for durability.

0CHCS3B

F

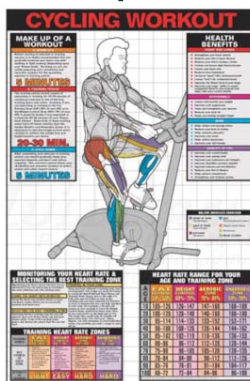

F. CYCLING WORKOUT

Detailing the muscles involved while using the Stationary Cycle. The chart is 24" x 36" and is laminated for durability.

0CHCS4E

G

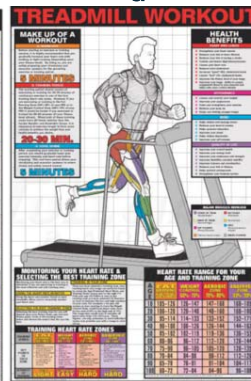

G. TREADMILL WORKOUT

Detailing the muscles involved while using the Treadmill. The chart is 24" x 36" and is laminated for durability.

0CHCS5B

H

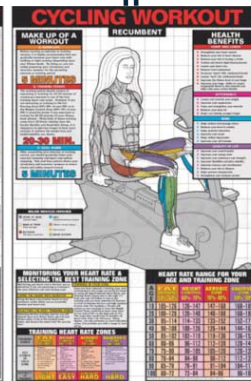

H. RECUMBENT CYCLING WORKOUT

Detailing the muscles involved while using the Recumbent bike. The chart is 24" x 36" and is laminated for durability.

0CHCS6E

RUBBER FLOOR MATS

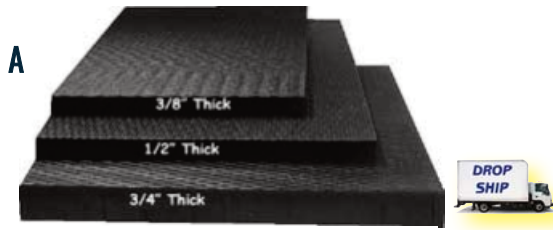

A. RUBBER FLOOR MATS

Supersport mats are the best protection available for sports floors and equipment. Made from 100 % recycled rubber with a non-skid finish. We do not recommend the mats be glued to the floor, but they can be secured with the mat tape sold below. Available in black 4' x 6' sections. The edges are perfectly squared so there is no space between mats. Mats ship direct from manufacturer.

3/8" THICK - 55 LBS EACH

ORM3/8-4X6	1 - 10 mats
ORM3/8-4X6OVER10	11- 29 mats
ORM3/8-4X6OVER30	30 or more mats

1/2" THICK - 75 LBS EACH

ORM1/2-4X6	1 - 10 mats
ORM1/2-4X6OVER10	11 - 29 mats
ORM1/2-4X6OVER30	30 or more mats

3/4" THICK - 105 LBS EACH

ORM3/4-4X6	1 - 10 mats
ORM3/4-4X6OVER10	11- 29 mats
ORM3/4-4X6OVER30	30 or more mats

OVER 10 MATS CALL FOR QUANTITY DISCOUNT
To figure out how many mats are needed:
Length x width divided by 24 = number of mats needed

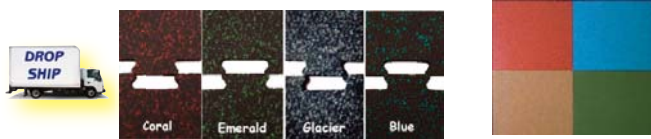

Speckled Rubber Mats & 95% Color Mats are available please call for pricing.



D

D. ROLLED FLOORING

This flooring is durable, versatile slip resistant and easy to install. Rubber is 4' wide and available in thicknesses of 1/8", 1/4", 5/16", 3/8" and 1/2". Standard colors include black, blue, gray, terra cotta, eggshell & green fleck. Also in a combination of blue and gray fleck. Ships direct from manufacturer.



B

B. HEAVY DUTY STAIRCLIMBER & BIKE MATS

Non-porous P.V.C. material. Easy to 3' x 4' x 1/8" Ships direct from manufacturer. 15 lbs
OTMP-DS

HEAVY DUTY TREADMILL, ROWER & ELLIPTICAL

Non-porous P.V.C. material. Easy to clean, Beveled edges. Ships direct from manufacturer.

OTMP1-DS 3' x 6.5' x 1/8"

OTMP2 -DS 3' x 7.5' x 1/8"

C



C. 3' x 4' BEVELED EDGE MAT

Excellent for use under Stationary Bike or Steppers. They Shield the floor from damage while protecting the machines from vibration and carpet fibers. Ships direct from manufacturer.

ORM3/8-3x4 1 - 6

ORM3/8-3x4OVER6 6 or more

LOKTUFF INTERLOCKING FLOORING



•Loktuff interlocking flooring allows you to cover an entire room or any large "island".

•Loose lay product, requires no adhesive

•Will not curl or separate, insulates against cold

•Absolutely non-absorbent

•LOKTUFF precision water-jet cut interlock eliminates gaps

•Will not harbor or promote bacterial growth

•Mitigate agent added during manufacturing to reduce rubber smell

•Available in black or speckled color.

Sizes shown are not finished size of each mat. When creating a large floor area a floor plan is highly recommended. Mats are shipped direct from the manufacturer. Please email or call for more information

TOUGH, DURABLE FLOOR PROTECTION

SHIELDS YOUR FLOOR

Floor mats shield your floor from damage while also protecting your expensive workout equipment.

EXTEND THE LIFE OF EQUIPMENT

Mats also extend the life of your equipment by preventing floor debris, carpet fibers and dust from infiltrating equipment and reduces static which can damage belts, motors, electronics and mechanical parts.

REDUCES EQUIPMENT VIBRATION

Greatly reduces equipment vibration and static electricity.

RESILIENT MATERIAL

Resilient mat material will not be permanently pressed by even the heaviest equipment. When equipment is removed the mat returns naturally to its original thickness.

PERFECT IN ANY AREA

Perfect for weight rooms and exercise areas!

STRETCH MATS

A



A. POWER SYSTEMS PREMIUM CLUB MAT

One of our thickest mats! Comfortable mats with sponge-like feel provide excellent cushioning for any activity where a mat is needed. Nonslip surface is soft to the touch. Supportive closed-cell foam structure resists moisture and wipes clean with a damp cloth. Rolls for easy storage. 56" Long x 23" Wide x 5/8" Thick. Will ship separately, direct from manufacturer.

083511-5M-BL-5E Blue
083511-5M-JB-5E Black

B



B. POWER SYSTEMS PREMIUM HANGING CLUB MAT

These mats offer the same comfortable feel and quality constructions as the Premium Club Mats, but they have two reinforced rings so you can hang them on a rack and out of the way. Thick, sponge-like feel that provides excellent cushioning for yoga, stretching or any other activity where a mat is needed. Nonslip surface is soft to the touch.

72" x 23" x 5/8"

093824-DS Ocean Blue

093832-DS Jet Black

72" x 23" x 3/8"

093842-DS Ocean Blue

093840-DS Jet Black

56" x 23" x 5/8"

093828-DS Ocean Blue

093830-DS Jet Black

56" x 23" x 3/8"

093836-DS Ocean Blue

093834-DS Jet Black

C



C. POWER SYSTEMS WALL RACK FOR MATS

This simple adjustable wall rack for gym mats helps keep your tumbling mats off of the floor and out of the way when they are not in use. This solid wood rack with steel adjustable hangers fits most hanging fitness mats. Holds up to 14 mats. 4 lbs.

092555-DS

D

OUR BEST QUALITY!



D. FULL CIRCLE AEROBIC MATS

These mats are specially designed and manufactured by Full Circle Padding Inc., for use in aerobic classes or for stretching exercises. Mats are 1" polyurethane foam covered with the same heavy duty vinyl used on our replacement pads. (These mats are made to order and are not returnable) 26" x 48" x 1"

Black

0AMATBLK	1 - 5 mats
0AMATBLK6-19	6 - 19 mats
0AMATBLK20	20 or more mats

Your choice of color

0AMATSC	1 - 5 mats
0AMATSC6-19	6 - 19 mats
0AMATSC20	20 or more mats

FLOOR MATS



1" THICK STRETCH MAT - BEST QUALITY

Stretch mats are constructed of 1" thick dense X-link foam which will last longer than urethane foam. The mat is covered with heavy-duty 18 oz vinyl. The mats are 2' wide and are available as a 4' flat mat, 6' flat mat or 6' tri-fold mat. It's sturdy and durable construction makes it an ideal mat for schools, fitness clubs and home use.

.Available in colors listed below. Ships direct from the manufacturer.

- A. 110SFC160206-DS 2' x 6' x 1" Folding
- B. 110SFC160206N-DS 2' x 6' x 1" Non-folding
- C. 110SFC160204N-DS 2' x 4' x 1" Non-folding

D. 1 3/8" THICK BI-FOLD STRETCH MAT

Bi-fold mats are constructed of 1 3/8" dense X-link foam and covered in heavy duty 18 oz vinyl. Mats are 2' wide and fold in half with handles.

- 110SFC160205-DS 2' x 5' x 1 3/8"
- 110SFC160207-DS 2' x 6' x 1 3/8"

AVAILABLE COLORS

Navy	Lime Green	Lite Blue	Red	White
Dark Purple	Kelly Green	Navy Blue	Yellow	Gray
Pink	Green	Royal Blue	Orange	Black

**IF YOU HAVE TO REPLACE YOUR STRETCH MATS EVERY YEAR YOU HAVEN'T PURCHASED ONE OF OUR MATS!
OTHERS MAY LOOK SIMILAR BUT DON'T BE FOOLED BY IMITATIONS.**



E. HEAVY DUTY STRETCH MAT

These mats are made to last. The 2' panels are filled with 1 3/8" thick cross-linked polyethylene foam. They are covered with 18 oz vinyl, the most durable in the industry and fold accordion style for easy storage. Mats are easy to clean with mild soap and water and treated with antibacterial and anti-fungal agents. Velcro at each end is standard. Available in colors listed above. Ships direct from the manufacturer.

- 11040622-DS 4'x6'x1 3/8"
- 11040822-DS 4'x8'x 1 3/8"
- 11051022-DS 5'x10'x 1 3/8"
- 11061222-DS 6'x12'x1 3/8"

CUSTOM MATS ARE AVAILABLE WITH VELCRO ON ALL 4 SIDES TO CREATE A LARGE STRETCHING AREA. ADDITIONAL CHARGES DO APPLY. CALL FOR MORE DETAILS!



F. DUMBBELL DROP MAT

The Dumbbell Drop Mat is ideal for placing next to your benches if on a wooden, vinyl tile or rubber floor. They absorb most of the impact helping to prevent damage to your floors and reduce the noise from dropping dumbbells or kettlebells. Each mat is 24" x 24" and 2-1/2" thick. Made with a high density foam and covered with a durable 18oz vinyl coated polyester. Ships direct from manufacturer.

DBMAT24X24-DS

A



A. I-BEAM PADS

Designed to minimize the hazards of body contact with steel support I-beams. Carefully crafted to provide the maximum protection. Easy to install. 4" thick high density polyfoam covered with 18 oz. coated vinyl. Attached with a velcro hook & loop system. I-beam pads are available up to 10" wide and 6' high. Ships direct from manufacturer. Instructions on how to measure I beam pads are available at the end of this catalog or on our website www.fullcirclepadding.com under the how to order tab. Fill in the information requested then fax or email to us for custom pricing.

B



B. POST PADS

These 6' high protective pads are to be installed around post areas where body contact may occur. Constructed using 18 oz coated vinyl covering and 4" thick high density urethane foam. They form around the post and secure with hook-and-loop fasteners. Specify square or round. Ships from manufacturer. Instructions on how to measure I beam pads are available at the end of this catalog or on our website www.fullcirclepadding.com under the how to order tab. Fill in the information requested then fax or email to us for custom pricing.

C



C. STAGE PADDING

If your gym does double duty as an auditorium or theatre the stage can present a clear and obvious danger to your athletes. Our stage pads are designed to conform exactly to your specific application. Made of 1 3/8" foam and 18 oz vinyl. Ships direct from manufacturer. Instructions on how to measure stage pads are available at the end of this catalog or on our website www.fullcirclepadding.com under the how to order tab. Fill in the information requested then fax or email to us fro custom pricing.

1050861call for pricing

D



D. WALL MOLDING STRIPS

Aluminum strips have 2" wide hook-and-loop fasteners on facing so mats can be quickly attached or detached. Permanent installation is easy and strips compliment room décor. **Sold in 6' sections only.** Ships direct from manufacturer 1100041

E



E. SAFE PRO BACKBOARD SAFETY PADDING

No glue padding kit fits any 72" wide glass backboard. Molding process produces a super-tough skin on the outside of the foam padding to allow for long life. Stay-put easy bolt-on attachment system. Meets NCAA and NFSHSA specs. Ships direct from manufacturer. Available colors: Black, Cardinal, Columbia Blue, Forest Green, Gray, Kelly Green, Maroon, Navy, Old Gold, Orange, Purple, Royal Blue, Scarlet, Texas Orange, Yellow.

05054XXXX



PROTECTIVE PADDING

A



A. BACKSTOP PADDING

Backstop padding is constructed with 18 oz coated vinyl with 2" polyurethane foam and sewn in 2' panels for easy storage. Pads are made with a 2" flap on all four sides and evenly spaced grommets for attachment. They can be easily bolted to wood backstops or tied with nylon cable ties (not included). Also available with full color digital graphics. Custom sizes are available please call for more information.

1050206	2' x 6'	1050312	3' x 12'	1050507	5' x 7'
1050210	2' x 10'	1050406	4' x 6'	1050510	5' x 10'
1050306	3' x 6'	1050408	4' x 8'	1050512	5' x 12'
1050308	3' x 8"	1050410	4' x 10'	1050609	6' x 9'
1050310	3' x 10'	1050412	4 x 12'		

B



B. STADIUM FIELD PADDING

Stadium field padding is constructed of 18 oz vinyl, 3/4" exterior grade plywood primed and sealed. The 3" urethane foam is then bonded to the plywood. Each panel is then fitted with thick Z brackets which are re mounted to the back. Available with or without graphics. Custom Sizes are available please call for more information. Ships direct from the manufacturer by truck

1086000	4' x 8' Field Pad	1086100	4' x 10' Field Pad
----------------	-------------------	----------------	--------------------

C



D



E



**Perfect protection for fence tops and rails.
All pads are constructed of heavy duty 18 oz vinyl and poly foam.**

C. FENCE TOP PADDING

Fence top pads will fit a fence top up to 2" in diameter. They are filled with 1" polyfoam with a flap and grommets every 6' for easy attachment to the fencing. Sold in 6' sections for easy placement but can be custom made to fit any shape and size of area. Ships direct from the manufacturer by truck. **1040100**

D. FLAT RAIL PADDING

Flat rail padding is an excellent choice for those hard to cover areas where a round pad will not work. Pads attach with grommets which can be secured with cable ties or rope. Any custom size and thickness is available. Please call for custom sizes. Ships direct from the manufacturer.

- 1040280** 1" thick x 6" wide
- 1040290** 1" thick x 7" wide
- 1040300** 1" thick x 8" wide (will fit 2" pipe)
- 1040310** 1" thick x 9" wide (will fit 2.5" pipe)
- 1040283** 3" thick x 6" wide

E. DUGOUT RAIL PADDING

Similar to the fence top pad but available with either velcro closure or grommet strips. Ships direct from the manufacturer.

	<u>Velcro Closure</u>	<u>Grommets</u>
1.5" inside diameter	1040150V	1040150
2" diameter	1040200V	1040200
2.5" diameter	1040250V	1040250

WALL PADDING



A

A. WALL MATS

Wall padding will absorb a great deal of impact. Our wall padding is made using 1/2" thick plywood backing, 2" high density urethane foam and is permanently covered with tough 18 oz coated vinyl. A 1" lip is left at top and bottom of pad for attachment to the wall. Can be bolted directly to the wall or by using aluminum channeling. 5, 6, 7 foot mats are available, call for prices. Ships direct from manufacturer. Please call for instructions on how to measure.

Available Colors: Black, Charcoal, Grey, White, Tan, Brown, Burgundy, Red, Orange, Yellow, Green, Royal Blue, Light Blue, Kelly, Lime, Pink, Dark Purple, Navy

1087118	2' x 4' x 2", 18 oz
1087218	2' x 5' x 2", 18 oz.
1087318	2' x 6' x 2", 18 oz.
1087418	2' x 7' x 2", 18 oz.

1087002	Wall mat cutout
1087001	Charge for corner

WALL MATS WITH GRAPHICS

1087218G	2' x 5' x 2", 18 oz. with graphics
1087318G	2' x 6' x 2", 18 oz. with graphics
1087418G	2' x 7' x 2", 18 oz. with graphics

A. CLASS A FIRE RATED WALL PADDING

Class A pads are constructed of 7/16" OSB Board, with 2" highly flame resistant polymerized open cell foam and covered with 16oz FR rated vinyl. Pads have a 1" lip top and bottom for attachment to the wall. (hardware is not included) Can be bolted directly to the wall or by using aluminum channeling sold below. FR Wall padding panels comply with the standards set forth by ASTM E84. This class "A" rated product meets NFPA 255, UL 723, ANSI 2.5 and UBC 8-1 (42-1).

1084118	Wall Mat 2' x 4' x 2" E-84
1084218	Wall Mat 2' x 5' x 2" E-84
1084318	Wall Mat 2' x 6' x 2" E-84
1084418	Wall Mat 2' x 7' x 2" E-84
1084518	Wall Mat 2' x 8' x 2" E-84

CLASS A FIRE RATED WALL PADS WITH GRAPHICS

1084118G	Wall Mat 2' x 4' x 2" E-84 with graphics
1084218G	Wall Mat 2' x 5' x 2" E-84 with graphics
1084318G	Wall Mat 2' x 6' x 2" E-84 with graphics
1084418G	Wall Mat 2' x 7' x 2" E-84 with graphics
1084518G	Wall Mat 2' x 8' x 2" E-84 with graphics

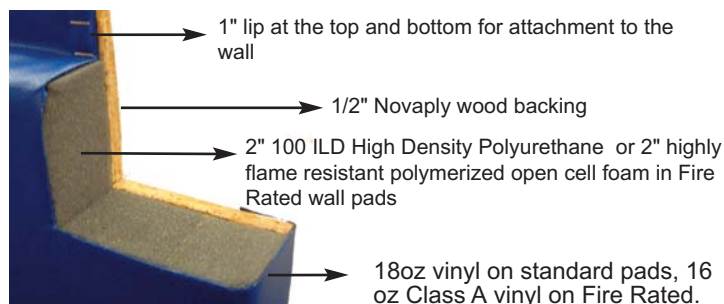

B

B. ALUMINUM CHANNELING

Aluminum channeling is the fastest and easiest method for attaching wall padding to your walls. Channel has a locking top which will keep the padding secure and cover any bolts or the top of the pad. Removal is simple and allows easy replacement of damaged padding. Available in 6 foot sections only.

1087000

"L" CHANNEL ONLY (NOT PICTURED)

For use on bottom lip of wall pads. Secure channel to the wall then slide the pads into the channel. Top of pads can be screwed directly to the wall. Sold by the linear foot.

10870-L

"Z" CHANNEL MOUNTED TO PAD (NOT PICTURED)

Recommended for wall pads 7' high and over. Channel is screwed on the back of the pad to the middle. An additional Z is provided to attach to the wall. This helps to support the middle of the pad and prevent sagging. Sold by the linear foot.

10870-Z6

**THE BEST IN THE INDUSTRY
CALL FOR A SAMPLE**

DIGITAL



Digital graphics utilizes a 6 color process, using special durable inks that produce extreme and intense life size outdoor quality images. The vinyl is then protected with a liquid lamination process to provide added durability and prevent fading. The lamination process does change the appearance of the mats giving them a glossy finish.

All you need to send us is a clean copy of your logo or a digital photo. If you would like assistance with your logo please let us know. All images will be sent to you for final approval prior to printing the product.

DUMBBELLS & KETTLEBELLS

A. HEX DUMBBELLS

Our Solid hex dumbbells are designed by Cap Barbell with the user in mind. The highest quality gray iron casting available, ASTM-grade 20 is used to manufacture the dumbbells. Available in increments of 1 lb, 2 lb, 3 lb, 5 lb, 8 lb, 10 lb, 12 lb, and 15 - 100 lbs in 5 lb increments. Will not fit on dumbbell racks with saddles.

OHDB

B. CAP BARBELL HEX DUMBBELLS WITH RUBBER HEADS

Contoured handles maximize the feeling of control and elastic rubber heads help to prevent damage to floors. Rubber is up to 3/8" thick. Available in increments of 3 lb, 5 lb, 8 lb, 10 lb, 12 lb and 15 to 100 lbs in 5 lb increments. Will not fit on dumbbell racks with saddles.

OSDR

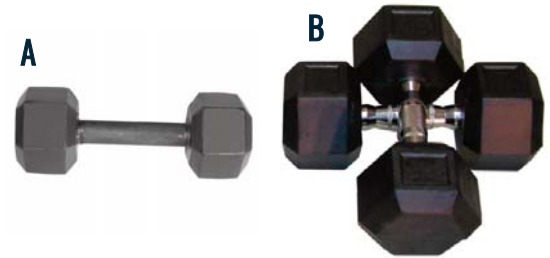

C. HEX PLATE-MATES

Hex Plate-Mates attach to weights securely with three super strong magnets. Versatile design fits solid-poured dumbbells, Olympic bars, power blocks, and stack weight machines.

0HWPP1.25 1 1/4 lb Hex Plate-Mate

D. DONUT PLATE MATE

Plate-Mate Donuts fit securely over the ends of pro-style dumbbells. Plate-Mates are versatile. With just two pairs of 2 1/2 lb Donuts, you can buy dumbbell sets in 10 lb increments and save. The Plate-Mate Donut also works on hex weights of 20 lbs or more.

0DWPP1.25 1 1/4 lb Round Plate-Mate 2.5 lbs per pair

0DWPP2.5 2 1/2 lb Round Plate-Mate 2.5 lbs



E. CAP KETTLEBELL

Kettlebell training develops strength, power, endurance and balance. Working with kettlebells will sculpt and tone the entire body, specifically at the core. This is a great option for getting a total body workout. Kettlebells have a polished black finish. Ships direct from manufacturer.

OSDK2010	10 lb
OSDK2015	15 lb
OSDK2020	20 lb
OSDK2025	25 lb
OSDK2030	30 lb
OSDK2035	35 lb
OSDK2040	40 lb
OSDK2045	45 lb
OSDK2050	50 lb
OSDK2060	60 lb
OSDK2070	70 lb

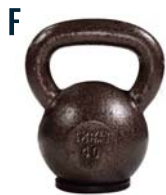

F. POWER SYSTEMS ULTRA KETTLEBELL

Cast-iron bell with rubber plate bottom to prevent damage to floors and racks. Smooth, solid steel handle for comfortable grip. Handle measures 1" diam. on 10 lb. kettlebell and progressively increases to 1 3/8" diam. on 100 lb. Weight # is cast in each for ease of identification. Ships direct from manufacturer.

050140-05-DS	5 lb	050140-40-DS	40 lb
050140-10-DS	10 lb	050140-45-DS	45 lb
050140-15-DS	15 lb	050140-50-DS	50 lb
050140-20-DS	20 lb	050140-60-DS	60 lb
050140-25-DS	25 lb	050140-70-DS	70 lb
050140-30-DS	30 lb	050140-80-DS	80 lb
050140-35-DS	35 lb		



G. PREMIUM KETTLEBELL

Body-Solid Premium Kettlebells feature a chrome handle with dipped rubber base. Ships direct from manufacturer.

OKBC05-DS	5 lb
OKBC10-DS	10 lb
OKBC15-DS	15 lb
OKBC20-DS	20 lb
OKBC25-DS	25 lb
OKBC30-DS	30 lb
OKBC35-DS	35 lb
OKBC40-DS	40 lb
OKBC45-DS	45 lb
OKBC50-DS	50 lb
OKBC55-DS	55 lb
OKBC60-DS	60 lb
OKBC65-DS	65 lb
OKBC70-DS	70 lb
OKBC75-DS	75 lb

Order 4 or more kettlebells any combination and receive 10% off your kettlebell order.

This item ships direct from manufacturer.

Large orders or kettlebells over 70lbs will ship via freight carrier. You will be contacted with freight quote prior to shipment.

VINYL & NEOPRENE DUMBBELLS

A. TROY BARBELL VTX BLACK NEOPRENE DUMBBELLS

Premium neoprene hex dumbbells. Will not rust, crack or fade. Available in sizes 1 - 10, 12, 15 lb. Ships direct from manufacturer



0GTD001-DS	1 lb
0GTD002-DS	2 lb
0GTD003-DS	3 lb
0GTD004-DS	4 lb
0GTD005-DS	5 lb
0GTD006-DS	6 lb
0GTD007-DS	7 lb
0GTD008-DS	8 lb
0GTD009-DS	9 lb
0GTD010-DS	10 lb
0GTD012-DS	12 lb
0GTD015-DS	15 lb



B. COMPACT DUMBBELL RACK

This compact dumbbell rack from Troy Barbell holds up to 10 pairs of vinyl or neoprene coated dumbbells. The attractive design requires only 20 square inches of floor space. 20" x 20" x 28", 23 lbs Ships direct from manufacturer.

DUMBBELLS SOLD SEPARATELY
0THDR-DS



TROY BARBELL VTX COLORED VINYL DUMBBELLS

Premium bright vinyl coated dumbbells. Contoured handles. Ships direct from manufacturer.

C.	0VD001-DS	1 lb	Dk Pink
D.	0VD002-DS	2 lb	Purple
E.	0VD003-DS	3 lb	Green
F.	0VD004-DS	4 lb	Lt Blue
G.	0VD005-DS	5 lb	Dk Blue
H.	0VD006-DS	6 lb	Red
I.	0VD007-DS	7 lb	Dk Purple
J.	0VD008-DS	8 lb	Black
K.	0VD009-DS	9 lb	Yellow
L.	0VD010-DS	10 lb	Orange
M.	0VD012-DS	12 lb	Violet
N.	0VD015-DS	15 lb	Forest Green

O. POWER SYSTEMS VINYL DUMBBELLS

Cast iron dumbbells encased with a thick vinyl shell. Small, compact design for stacking and storing. Weight printed on ends for easy identification. Color coded by weight; colors may vary. Ships direct from manufacturer.

061700-01-DS	1 lb	Orange
061700-02-DS	2 lb	Green
061700-03-DS	3 lb	Red
061700-04-DS	4 lb	Lt. Blue
061700-05-DS	5 lb	Purple
061700-06-DS	6 lb	Gray
061700-07-DS	7 lb	Black
061700-08-DS	8 lb	Orange
061700-09-DS	9 lb	Green
061700-10-DS	10 lb	Red
061700-12-DS	12 lb	Lt. Blue
061700-15-DS	15 lb	Purple



PRO STYLE DUMBBELLS

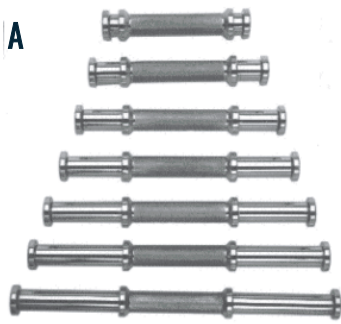

A. STRAIGHT PRO STYLE HANDLES

Solid one piece with extra long fine thread bolts for secure locking. See chart below to determine which size handle is needed. Hardware included.

- 0SDH1
- 0SDH2
- 0SDH3
- 0SDH4
- 0SDH5
- 0SDH6
- 0SDH7
- 0SDH8



END CAPS

For use with pro style dumbbells and barbell handles shown on this page.

- B. **0B359HW5R** Rubber Encased for hex bolt only.
- C. **0B359ER2** Rubber
- D. **0RPC000** Chrome
- E. **0RPB000** Black

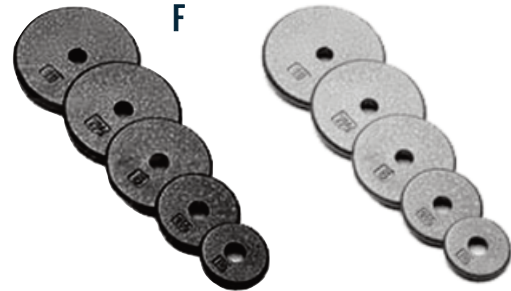

F. STANDARD PLATES

In black or gray. Available in weights of 2 1/2 lb, 5 lb, 7 1/2 lb, 10 lb, 12 1/2 lb, 25 lb, 50 lb.. For use with pro style dumbbells and barbell handles shown on these pages.

- 0RPB** Black
- 0RPG** Gray

BUILD YOUR OWN CAP PRO STYLE DUMBBELLS

WITHOUT END CAPS

Assembled using the bolt and large chrome washer.

Dumbbell weight does not include weight of

- When ordering pro style dumbbells please note that they are shipped unassembled.
- Dumbbells without end caps do not include the weight of the handle. A 25 lb dumbbell without end caps actually weights 27 3/4 lbs.
- Assembly is available for an additional charge of \$15.00 per pair.

For dumbbell racks please see page 23.

WITH END CAPS

Dumbbells using bolt and 1 1/4 lb end cap without chrome washer
Dumbbell weight includes weight of handle.

DUMBBELL WEIGHT	SDH	ORP10	ORP7.5	ORP5	ORP2.5
10	1			2	
20	1	2			
30	2	2		2	
40	2	4			
50	3	4		2	
60	3	6			
70	4	6		2	
80	4	8			
90	5	8		2	
100	5	10			
110	6	10		2	
120	6	12			
130	7	12		2	
140	7	14			
150	8	14		2	
160	8	16			
170	9	16		2	

LOCKTITE AND TIGHTENING KITS ARE AVAILABLE ON PAGE 40

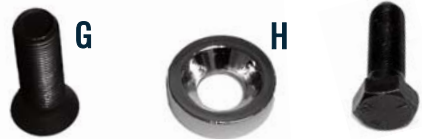

DUMBBELL & BARBELL HANDLE BOLTS & WASHERS

HANDLE BOLTS AND WASHERS

- G. **FWP621** Bolts
- H. **FWP622** Washers

I. HEX BOLT

Fits only 0B359HW5R end cap sold above. 1/2 lb 0B359HB3

DUMBBELL WEIGHT	SDH	ORP10	ORP7.5	ORP5	ORP2.5	END CAPS
20	1		2			2
30	2	2			2	2
40	2	2	2			2
50	3	4			2	2
60	3	4	2			2
70	4	6			2	2
80	4	6	2			2
90	5	8			2	2
100	5	8	2			2
110	6	10			2	2
120	6	10	2			2
130	7	12			2	2
140	7	12	2			2
150	8	14			2	2
160	8	14	2			2
170	9	16			2	2



DUMBBELL & KETTLEBELL RACKS



A. AEROBIC PACK WITH NEOPRENE DUMBBELLS

Rack and black neoprene dumbbells. Includes 14-1 lb., 12-2 lb., 18-3 lb., 16-5 lb., 14-8 lb., 12-10 lb. Wheels are included. 38" L x 45 1/4" H x 16 1/4" W Ships direct from manufacturer. 525 lbs
OMDR-NPAC

OMDR-CASTERS Optional casters

B. AEROBIC PAC WITH VINYL DUMBBELLS

The Aerobic Pac from USA Sports, comes complete with display rack and 43 pairs of vinyl coated dumbbells. 14-1 lb., 12-2 lb., 18-3 lb., 16-5 lb., 14-8 lb., 12-10 lb. Measures 46"x40"x26" Ships direct from manufacturer. 525 lbs
OMDR-VPAC

OMDR-CASTERS Optional casters

C. RACK ONLY

In black. Security bar can be locked (lock not included) 500 lb capacity. 38" L x 45 1/4" H x 16 1/4" W Ships direct from manufacturer. 125 lbs.

THESE ITEMS SHIPS FOR FREE!

0RK10-DS Rack

0RK10W-DS Wheel Attachments



D. POWER SYSTEMS VERTICAL DUMBBELL RACK

Space-saving design stores and protects dumbbells in individual cradles. Holds a complete set of 1 lb. to 15 lb. dumbbells. Steel construction. Assembly required. Black. Ships direct from manufacturer. 28" L x 23" W x 50-1/2" H.
061788-DS

E. COMPACT DUMBBELL RACK

This compact dumbbell rack from Troy Barbell holds up to 10 pairs of vinyl or neoprene coated dumbbells. The attractive design requires only 20 square inches of floor space. 20" x 20" x 28"
DUMBBELLS SOLD SEPARATELY Ships direct from the manufacturer. 23 lbs
0THDR-DS

Dumbbells sold separately



Kettlebells sold separately

F. POWER SYSTEMS PREMIUM KETTLEBELL RACK

Keep your kettlebells off the floor and in order. Rack stores up to 12 kettlebells. Kettlebells sit securely in 3 trays. Steel construction. Assembly required. Gray/Black. Dimensions 32" L x 22" W x 46" H". Ships direct from manufacturer. (Kettlebells Not Included) 78 lbs
050090-DS

G. POWER SYSTEMS CLUB PREMIUM KETTLEBELL RACK

This 3 tier kettlebell rack is ideal for keeping all your bells organized and off the floor. Each shelf has a rubber mat to help protect the rack and reduce noise. The lip on the back of each shelf to prevent your kettlebells from falling through. Shelf measurements: Top Shelf 8" x 54", Middle Shelf 9" x 54", Bottom Shelf 10" x 54", Rack footprint measures 54" L x 25" D x 36" H. Kettlebells not included. Ships direct from manufacturer.
050095-DS

H. TAG 2 TIER KETTLE BELL RACK

14 gauge 2" x 4" oval steel tube frame construction, Rubber feet to protect floor. Shelves 40" x 12-1/2", Footprint 40" x 22" x 26", Lifetime warranty on welds, 1 year on parts. Ships direct from manufacturer.

0RCKKBR2-DS

I. TKO KETTLEBELL RACK

This high quality TKO Kettlebell Rack is great for any club or personal training studio. The rack is made with durable 14 gauge 2" x 4" oval tube steel as well as 7 gauge steel shelves. Rack also has rubber feet to protect the floor. The 2 tier open design allows easy access to the kettlebells. Assembled dimensions are 40" W x 22" D x 26" H with the shelves measuring 40" W x 12-1/2" D

0859KR-DS

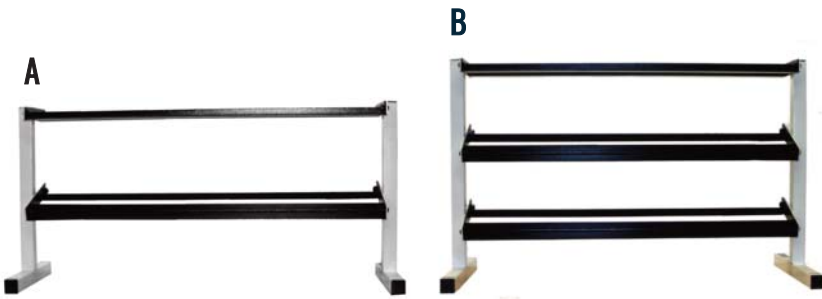

2 & 3 TIER DUMBBELL RACKS

These racks are made with 12 gauge steel with angled lower level for easy lifting. Designed to prevent fingers, thumbs and hands from getting pinched and dumbbells from sliding off. Tiers measure 10 1/2" wide. Not for use with vinyl coated or neoprene dumbbells. **FREE SHIPPING**

A. 2 TIER

50" long, will hold most styles of dumbbells from 5 - 50 pounds. Ships direct from manufacturer. 54" L x 26" H x 18.5" W, 85 lbs **ORK3-DS**

B. 3 TIER

48" long, will hold most styles of dumbbells from 5 - 70 pounds. 2000 lb capacity. Ships direct from manufacturer. 53" L x 32 1/2" H x 24" W 115 lbs **ORK3E-DS**



C. 10 PAIR HORIZONTAL DUMBBELL RACK

This commercial 10 pair rack has a rugged 3" x 2" frame with a scratch resistant powder coat finish and anatomically angled tiers for easy access. Durable plastic saddles help protect dumbbells and reduce noise. Rack Measures: L 98" x W 25" x H 31. Ships direct from manufacturer 137lb **ODR10-DS**



Dumbbells not included

D. TAG X RACK

The Tag Fitness X Rack is build to hold 10 pairs of dumbbells and comes with nylon saddles. Rack has a lifetime warranty on welds and 6 months on parts. Rack measures 37" Wide x 22" Deep x 52" Tall, Dumbbells not included. Ships direct from manufacturer. **ORCKXDBR-DS**



Dumbbells not included

E. 3 TIER DUMBBELL RACK

FREE SHIPPING!

Heavy gauge steel with all-4-side welded construction is deburred inside and out for user safety. 40" Wide 3-Tier Dumbbell Rack #WDR363. Holds one (1) pair each of 5-50 lb. hex dumbbells. Dimensions: 30"H x 20"L x 40"W. Ships direct from the manufacturer. 47 lbs

OGDR363-DS



F. BODYSolid DUAL DUMBBELL/KETTLEBELL RACK

FREE SHIPPING!

Made by BodySolid this rack features configurable weight platforms that flip to hold either dumbbells or kettlebells. It can be placed against any wall or centered in a room. Heavy gauge steel with all-4-side welded construction is deburred inside and out for user safety. 23" wide, 33" high, 44 1/2" long, Tray dimensions - 11" deep x 39" wide. Ships direct from the manufacturer. 79 Lb.

OGDKR100-DS

DUMBBELL RACKS

All racks on this page ship direct from the manufacturer.



FREE SHIPPING ON THESE RACKS!

A. ECONOMY A FRAME DUMBBELL RACK

Holds up to 5 pair of Hex Dumbbells. Staggered levels allow for easy access and management of dumbbells. Smaller than the d2, this design offers maximum efficiency for compact areas. Perfect for Hex and Rubber Hex Dumbbell. Rack Dimensions: 15" x 13" x 26", Weight Capacity: 200lb

ORK12B-DS

B. A FRAME DUMBBELL RACK

CAP's two-tier vertical dumbbell rack can hold up to 6 pair of Hex Dumbbells. Staggered levels allow for easy access and management of dumbbells and better efficiency in compact areas. Perfect for Hex and Rubber Hex Dumbbells from 5lb - 30lb. Rack Dimensions: 20.5" x 16" x 33", Weight Capacity: 300lb

ORK12-DS

C. 4 SIDED VERTICAL DUMBBELL RACK

Designed with heavy-gauge steel, the 4 Sided Vertical Rack offers maximum stability and long lasting performance. Capable of housing up to 10 pairs of Hex, Rubber Hex or Chrome Dumbbells between 5lb - 50lb. Black finish with rubber contact points. Rack Dimensions: 23.6" x 23.6" x 37.4". Weight Capacity: 750lb

ORK17-DS

D. 2 SIDED VERTICAL DUMBBELL RACK

The 2 Sided Vertical Rack, made with heavy-gauge steel, offers stability and long lasting performance. Capable of housing up to 6 pairs of Hex, Rubber Hex, or Chrome Dumbbells between 5lb - 30lbs. Black finish with rubber contact points. Rack Dimensions: 23.6" x 11" x 37.4" Weight Capacity: 500lb

ORK18-DS



E. 44" THREE TIER BEAUTY BELL RACK

This rack is for use with CAP SDC or SDCG chrome dumbbells only. Perfect for studios or home use. Holds 1 pair each of CAP's 5, 8, 10, 12, 15-50 lb SDC or SDCG chromed beauty bells (dumbbells). High impact saddles prevent scratches and dents to the chrome. Rack Dimensions: 42" x 24" x 31". Weight Capacity: 1000lb Ships direct from manufacturer. Call for shipping

ORK32-DS

F. 95" 2 TIER DUMBBELL RACK WITH SADDLES

Designed for home or commercial use. Heavy gauge, solid steel construction. Holds 10 pairs of dumbbells. Foot tabs with anchoring holes provide additional safety for clubs or vertical facilities. Rack Dimensions: 96" x 26" x 32". Weight Capacity: 2000lb Ships direct from manufacturer. Call for shipping

ORK30-DS

G. 52" THREE TIER STADIUM DUMBBELL RACK

Suitable for home or commercial applications. Solid steel frame and shelves will offer years of durability. Foot tabs with anchoring holes provide additional safety for clubs or vertical facilities. Rack Dimensions: 52" x 24" x 43". Weight Capacity: 2000lb Ships direct from manufacturer. Call for shipping

ORK31-DS



B



A. POWER SYSTEMS PRO CHALK CONTAINER

Keep your weight room clean by keeping your lifting chalk in the container. This large 23" diameter bowl is 5" deep. Rubber encased rim provides safety and helps keep chalk in bowl. Mounted on strong tubular steel stand with 4 swivel casters for easy movement. Assembly required. Black. 24" L x 24" W x 44" H. Chalk sold separately. Ships direct from the manufacturer.

068130-DS

B. GYM CHALK

Gym Chalk will give you the grip needed when working out. This 1 lb box contains 8 two ounce individually wrapped blocks. Made of pure grade natural magnesium carbonate.

OMA106

C



C.. MANTA RAY

This semi rigid device snaps onto any bar and helps you achieve the full advantage of performing the high bar squat with the proper upright posture, without discomfort. 2 lbs

OMR136

D



D. ARM BLASTER

Maximizes your bicep and tricep workouts by allowing maximum stability and isolation. Reinforced nylon shoulder straps and ergonomic padding with high density foam.

3 lbs

OMAB101

E



E. POWER LIFTING STRAPS

OH660

F. PRO WRIST WRAPS

OH650

G. PRO POWER GRIPS

OMAT405

F



G





A. LAT BLASTER BAR

This highly specialized design automatically hits the Lats at the ideal bio-mechanical angle providing lower back protection and full range of motion. Easily fits on all Standard and Olympic bars. 6 lb
0LBB28

B. T-BAR ROW PLATFORM

Simply put one end of the bar in the Platform cup and load up the other end with weight. The T-Bar Platform features oversized solid steel axle pivot point with dual bronze oil-lite bushings that lock solid to any 2" tubing or it can be bolted to the floor. Full 360° swivel ability makes it easy to use in tight spaces. 5 lbs
0TBR10

T-BAR ROW PLATFORM & LAT BLASTER BAR

Buy Both and Save! 15 lbs
0TBAR

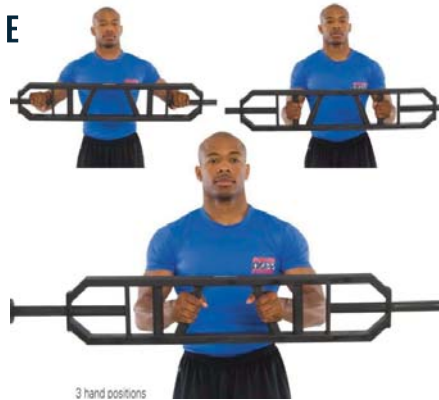

E. POWER SYSTEMS MULTI-GRIP BAR

the Power Systems Multi Grip Bar has 3 different hand positions giving you more options with one bar. The ergonomic hand placement options help reduce stress on the shoulder and wrist joints. Bar measures 84" L and is made of a heat treated alloy. Ships direct from manufacturer.
050080-DS



LANDMINE

A ground-based rotational training device that works the entire body. Perform explosive 1- and 2-arm movements and other rotational exercises simply by inserting any Olympic-size bar (not included) into the 12" pivoting sleeve at the units base. A 4" sleeve holds standard 1" bars. Portable for use in or out of the weight room; includes handle for easy transport. Solid steel. Nonskid rubber bottom. Assembly required. Black. Base: 19-1/2" L x 16" W.

Combine with the Wide Handle for work that targets the shoulders, core, and hips. Wide handle has ergonomic grips positioned approximately 26" apart covered in thick foam padding. Solid steel. Black. Connector pivots side to side and top to bottom. Ships direct from the manufacturer.

C. LANDMINE ONLY

060059-L1-DS

LANDMINE WITH WIDE HANDLE

060059-K1-DS

D. WIDE HANDLE ONLY

060059-L2-DS

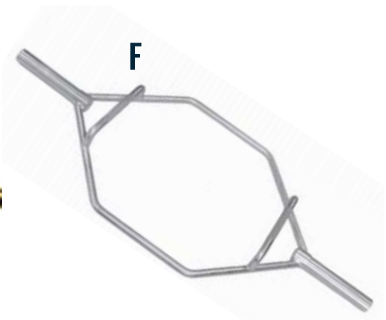

F. HEX BAR

Can stand any test of strength Made from heavy-duty alloy steel Made to the specifications of IPF and IWF Medium depth diamond knurled grips for your comfort 2" bar sleeves can accommodate all the 2" plates on the market. Bars are designed and engineered to develop specific groups of muscle according to the anatomical and physiological structures Bar sleeves swivel at the most delicate touch which prohibits the bar from warping and reduces pressure on your wrists Ships direct from manufacturer. 50 lbs
00B88H



G. POWER SYSTEMS PRO BAR WRAP PAD

Premium 1-1/2" nylon-covered foam pad with Velcro closure. Black. Length: 18". Ships direct from the manufacturer.

067088-DS

H. SQUAT BAR PAD

Extra dense 3/4" padding covered by black nylon with hook and loop closure.

OMA10518 - 18" long

I. EXTRA LONG SQUAT BAR PAD

Same as heavy duty squat bar pad but measures 18" long. 1/2 lb
OMA105HDL

OLYMPIC PLATES



A. BODYSOLID GRIP PLATES

These gray iron plates contain four grips for easy use and handling. Available in 2.5 lb, 5 lb, 10 lb, 25 lb, 35 and 45 lb. ships directly from manufacturer.

- 0OPT2.5 2.5 lb
- 0OPT5 5 lb
- 0OPT10 10 lb
- 0OPT25 25 lb
- 0OPT35 35 lb
- 0OPT45 45 lb



B



C



D



E



F



G

AMERICAN BARBELL URETHANE OLYMPIC PLATES

American Barbell Urethane Olympic Plates feature cutting-edge design and technology. High durometer urethane makes for lasting performance and durability in the most demanding of commercial training environments. The four hole grip feature allows easy loading onto the bar and a safer alternative for carrying. Ships direct from manufacturer.

These are not bumper plates and are not designed for or warranted against dropping.

- B. 0OPAB1025-DS 2.5 lb
- C. 0OPAB105-DS 5 lb
- D. 0OPAB110-DS 10 lb
- E. 0OPAB125-DS 25 lb
- F. 0OPAB135-DS 35 lb
- G. 0OPAB145-DS 45 lb



H

H. OLYMPIC PLATES

Cast iron gray baked enamel or standard black finish with raised silver accent letters. For use on 2" bars. Weights of 2 1/2 lb, 5 lb, 10 lb, 25 lb, 35 lb, 45 lb and 100 lb.

- 0OPB Black
- 0OPG Gray (Hammertone)

OLYMPIC PLATES

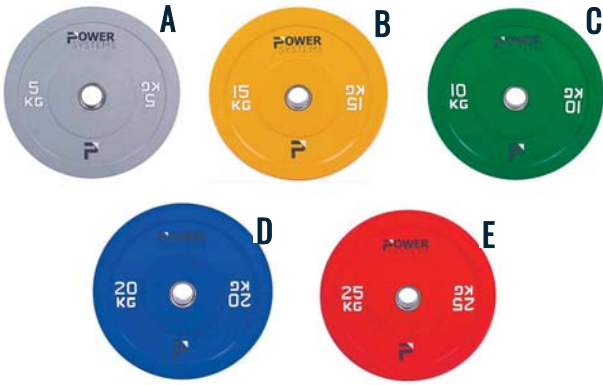

POWER SYSTEMS OLYMPIC BUMPER PLATE

The Power Systems Olympic Bumper Plates are constructed with sound dampening rubber. Plates have a inner stainless steel ring for added durability. Plates come in competition colors and weights.

- A. 055894-DS 5 kg = 11.0231 lbs
- B. 055895-DS 10 kg = 22.0462 lbs
- C. 055896-DS 15 kg = 33.0693 lbs
- D. 055897-DS 20 kg = 44.0925 lbs
- E. 055898-DS 25 kg = 55.1156 lbs



VTX OLYMPIC BUMPER PLATE

The solid rubber bumper plate are designed with a solid steel insert. These plate are ideal for any weight room setting. Plates display weight in both pounds and kilos.

- F. VTX010SBP-DS 10 lbs
- G. VTX015SBP-DS 15 lbs
- H. VTX025SBP-DS 25 lbs
- I. VTX035SBP-DS 35 lbs
- J. VTX045SBP-DS 45 lbs



K. VTX HORIZONTAL BUMPER PLATE RACK

Great for organizing your bumper plates the VTX bumper plate rack can hold upto eight 45lb plates as well as two plate horns on the handle to hold 2.5 lb and 5 lb add on weights. Rack comes with wheels and can hold a Maximum portable weight of 350 lbs. Maximum stationary weight is 650 lbs. Dimensions : L 50.75 x W 13.75 x H 22.75

Rack weight 31 lbs.
0GHBPR-DS



L. OLYMPIC PLATE RACK

Each plate holder measures 7 3/4". 500 lb capacity. Ships direct from manufacturer. 22" L x 37" H x 18" W 30 lbs
0RK2A-DS

FREE SHIPPING!



M. SPACE SAVER OLYMPIC PLATE RACK

Each plate holder measures 4". 300 lb capacity. Ships direct from manufacturer. 20" L x 30" H x 12" W 18 lbs

0RK2B-DS

FREE SHIPPING!

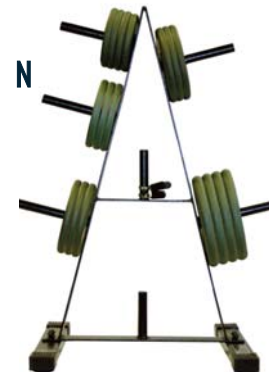

N. STANDARD PLATE RACK

500 lb capacity. Ships direct from manufacturer. 22 1/2" L x 37" H x 18" W 30 lbs

0RK1B-DS

FREE SHIPPING!

OLYMPIC BARS



A

B

C

BARS WITH LIMITED LIFETIME WARRANTY

FREE SHIPPING!

A. 5' HEAVY DUTY CURL BAR

Black bar, bronze bushings. 1 1/4" grip Limited Lifetime Warranty. Ships direct from the manufacturer. 29 lbs
0BT57B-DS

B. 5' HEAVY DUTY STRAIGHT BAR

Heavy duty 5' straight bar. Available in black 1 1/4" grip, bronze bushings. Limited Lifetime Warranty. Ships direct from manufacturer 31 lbs
0BT60B-DS

C. 7' OLYMPIC POWER BAR

1500 lb test 7' Oly bar, 1 1/16" shaft Black. No bend guarantee Limited Lifetime Warranty. Heavy duty use. Ships direct from the manufacturer. 44 lbs
0OB86PB-DS

CAP 7' OLYMPIC BARS

FREE SHIPPING!

Bars ship direct from manufacturer.

D. 7' OLYMPIC BAR

1200 lb test 7' Oly bar, black center with silver zinc sleeves. 1 1/16" shaft. Medium Duty use. 44lbs
0OB86B-DS

E. 7' OLYMPIC BAR

500 lb test 7' bar with shoulder bolts. 1 1/4" shaft. For light duty use. Ships direct from manufacturer.

0OB85B-DS 44 lbs Black
0OB85C-DS 44 lbs Chrome

F. 7' OLY CAMBERED BAR

Available in chrome 86" long. Ships direct from manufacturer. 48 lbs
0OB87-DS

G. 7' SILVER ZINC POWER BAR

Designed with medium depth diamond knurled surface and sleeves that swivels at the most delicate touch. This prohibits the bar from warping and reduces pressure on the wrists. 1500 Lbs.Capacity. Silver Zinc Finish. Ships direct from manufacturer. 45 lbs
0OB86PBSZ-DS

ULTRALIGHT OLYMPIC BAR (NOT PICTURED)

Measures 73" long with middle knurling. Fits on all standard bench presses. Weight capacity 200 lbs. **Weights only 30 lbs.** Ships direct from manufacturer.
0OB73UL-DS

ALUMINUM OLYMPIC BAR (NOT PICTURED)

Measures 73" long with middle knurling. Fits on all standard bench presses. Ships direct from the manufacturer. Weight capacity 200 lbs. Bar weighs only 15 lbs.
0OB73AL-DS



H

H. SUPRABAR CURL BAR

47" SupraBar deluxe curl bar with revolving handles is designed to increase upper arm mass, strength and definition. Used with any 2" Olympic plates, this bar isolates and intensifies development of the biceps and forearms through the biomechanical process of supination – the inward and outward rotation of the wrists. This SupraBar isolates exertion to the targeted muscle group while relieving stress on tendons and joints. Ships direct from the manufacturer. 26 lbs
0SBCB47-DS

OLYMPIC BARS & COLLARS

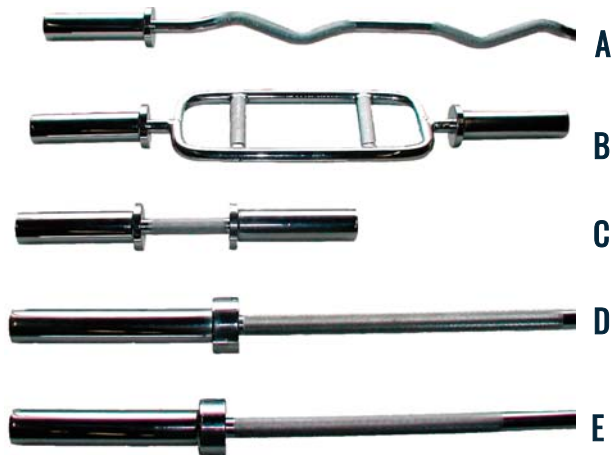

CAP SPECIALTY BARS

A. OLYMPIC CURL BAR

Features a wide grip. In chrome only. Includes FREE set of collars. 47" long. 18 lbs
00B47

B. OLYMPIC TRICEP BAR

Designed specifically for those hard to hit tricep muscles. Available in chrome. Includes FREE set of collars. Ships direct from manufacturer. 34" long. 24 lbs
00B34S-DS

C. OLYMPIC DUMBBELL HANDLE

5" long knurled handle with polished chrome finish. 20" long. Ships direct from manufacturer. 9 lbs
00B20-DS

D. 6" OLY BAR

Available in chrome only. 1 1/4" shaft. Ships direct from the manufacturer. 35 lbs **FREE SHIPPING!**
00B72C-DS

E. 5' OLY BAR

Available in chrome only. 1 1/4" shaft. Ships direct from the manufacturer. 30 lbs **FREE SHIPPING!**
00B60C-DS



L. OLYMPIC SPRING COLLARS

Heavy duty
00C06

M. TRAINING COLLARS

00C04

N. TAG LOCKING OLYMPIC COLLARS

The Tag Locking Olympic Collars are sold in pairs and fit all 2" Olympic Bars. Lightweight with a quick locking lever for easy on and off. Ships direct from manufacturer.

0ACCLBC-DS pair

O. MUSCLE CLAMP COLLARS

00C11 Black - pair

00C11R Red - pair

00C11B Blue - pair

00C11O Orange - pair

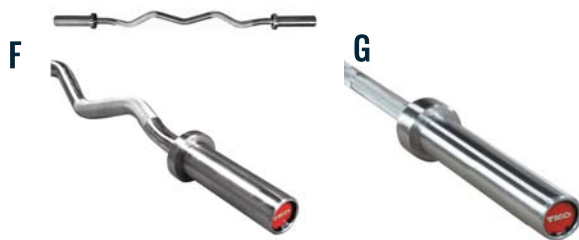

F. TKO 47" OLYMPIC CURL BAR

The TKO 47" Olympic Curl Bar comes with 2 needle bearings per sleeve for smooth rotation and double snap rings to secure the sleeves. With its hard chrome finish, 1-1/8" knurled bar and 200lb capacity this bar is ideal for any fitness club, facility or the home gym enthusiast. 25 lbs
0813OB47-DS

G. TKO 60" OLYMPIC STRAIGHT BAR

The TKO 60" Olympic Straight Bar has a hard chrome finish and 30mm knurled shaft. (Approximately 1-1/8") The double snap ring design holds the weight sleeves and the 2 needle bearings per sleeve are designed for ultra smooth rotation. Bar has a 300lb capacity. 33 lbs
0813OB60-DS



H. SQUAT BAR PAD

Extra dense 3/4" padding covered by black nylon with hook and loop closure.
0MA10518 - 18" long

I. EXTRA LONG SQUAT BAR PAD

Same as heavy duty squat bar pad but measures 18" long. 1/2 lb
0MA105HDL

J. POWER SYSTEMS PRO BAR WRAP PAD

Premium 1-1/2" nylon-covered foam pad with Velcro closure. Black. Length: 18". Ships direct from the manufacturer. 1/2 lb
067088-DS

K. POWER SYSTEMS OLYMPIC BAR STAND

Keep your weight lifting bars organized and off of the floor with our Olympic Bar Holder. This bar holder holds up to 6 weight lifting bars. With the base being weighted fall over if loaded unevenly. Ships direct from manufacturer. 35 lbs
040420-DS

FREEWEIGHT PARTS

A

10	80	130	200	250
20	90	140	210	260
30	100	150	220	270
40	110	160	230	280
50	120	170	240	290
60	105	180	135	300
70	225	190	285	310
320	370	20	45	80
330	380	25	50	85
340	390	30	55	90
350	400	35	60	95
360	5	40	65	100
165	10	195	70	225
3	15	2	75	1

B

10	140	65	275	10
20	150	75	280	11
30	160	85	290	12
40	170	95	300	13
50	180	210	1	14
60	190	215	2	15
70	200	220	3	16
80	5	230	4	17
90	15	240	5	18
100	25	245	6	19
110	35	250	7	20
120	45	260	8	21
130	55	270	9	22

C

10	80	130	200	250
20	90	140	210	260
30	100	150	220	270
40	110	160	230	280
50	120	170	240	290
60	105	180	135	300
70	225	190	285	310
320	370	20	45	80
330	380	25	50	85
340	390	30	55	90
350	400	35	60	95
360	5	40	65	100
165	10	195	70	225
3	15	2	75	1

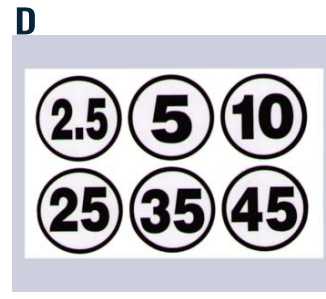

A. WEIGHT STACK DECAL'S

Clear background with black or white numbers. Increments as shown. Each numbered sticker measures 1-1/2" x 5/8".

FW160BK Black # decal's

FW160W White # decal's

B. WEIGHT STACK STICKER SET

Clear background, black numbers, increments as shown.

Each sticker measures 1 5/8" x 3/4".

FW163

C. PREMIUM LAMINATED NUMBER STICKERS

Thick premium stickers, black background with white numbers. 5 - 400 lbs.

Stickers measure 1 1/2" x 5/8".

FW160WK

D. OLYMPIC WEIGHT PLATE STICKER SET

White sticker with black outline and number. Great for labeling your olympic weight plate storage rack. Each sticker measures 1.5" across and includes one of each: 2.5 lbs, 5 lbs, 10 lbs, 25 lbs, 35 lbs and 45 lbs.

FW160A

E. WEIGHT STACK DECALS

Each sticker measures 3/4" x 3/8"

FW183 5 - 150 lbs

(5 - 100 in 5 lb increments, 10 - 150 lbs 10 lb increments)

FW184 10 - 400 lbs, in 10 lb increments

FW185 15 - 450 lbs in 15 lb increments

FW186 20 - 400 lbs in 20 lb increments



G. PADDED DUMBBELL STICKERS

Gold or silver finish metal, backed with high strength adhesive. Available from 5 to 300 lbs, not available in 1/2 lb increments. Sold individually or in a set.

GOLD - INDIVIDUAL STICKERS

FWSTICKER

GOLD - SETS

FWSTICKERSET1 2 each 5 - 50 lbs in 5 lb increments

FWSTICKERSET2 2 each 55 - 100 lbs in 5 lb increments

FWSTICKERSET3 2 each 105 - 150 lbs in 5 lb increments

F. DUMBBELL STICKERS

Heavy duty foil stickers. Black sticker with red outline and silver numbers.

Available in increments from 5 - 150 lbs. All 1/2 lb increments available are shown above. 1/2 lb

FWSTKR

DUMBBELL STICKER SETS

FWSTKRSET1 2 each 5 - 50 lbs in 2 1/2 lb increments

FWSTKRSET2 2 each 5 - 50 lbs in 5 lb increments

FWSTKRSET3 2 each 55 - 100 lbs in 5 lb increments

FWSTKRSET4 2 each 105-105 lbs in 5 lb increments



H. 5 7/8" HIGH IMPACT PLASTIC DUMBBELL SADDLE

High impact plastic. Hardware sold separately.

FWP620PLAS

I. 6 1/4" DUMBBELL SADDLE

Rubber coated cast iron for fixed dumbbells and barbells

FWP620

5" DUMBBELL SADDLE

Rubber coated cast iron for beauty, chrome and hex dumbbells.

FWP620A

J. DUMBBELL SADDLE HARDWARE

FWP620BT

ADD-ON WEIGHT

Rubber coated. Fits most weight stacks.

K. FWWSA5 5 lb

L. FWWSA2.5 2 1/2 lb

M. FWWSA7.5 7 1/2 lb

FREWEIGHT PARTS

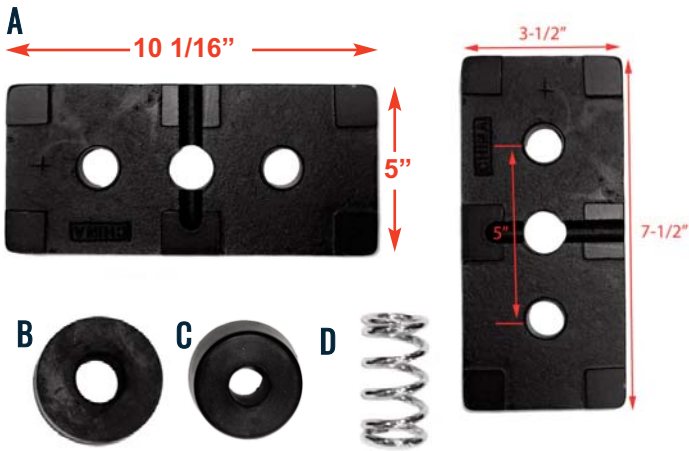

A. WEIGHT STACK PLATE

New Style 10lb Cast Plate

Thicker plate in weak area for longer life. Fits most Import stacks with 5" on center, 1" guide rods. Black

FW169-DS 10 lbs
FW165B-DS 5 lbs

RUBBER DONUTS

B. FWP480 1" dia x 1 1/2" high Rubber Donut
C. FWP480B 3/4" dia x 1" high Rubber Donut

D. WEIGHT STACK SPRING

3" H Duty Weight Stack Spring
FWP600A



URETHANE FOAM ROLLER

E. FWMAT711PU 7" x 1" x 4" concave roller
F. FWMAT710PU 7" x 1" x 4 1/2" diam
G. FWMAT712PU 8" x 1" x 4" Urethane Roller

FOAM ROLLERS

FWMAT708 18" x 1" x 4" diameter
H. FWMAT707 16" x 2" x 4 1/4" diameter
FWMAT709 16" x 1" x 4" diameter
I. FWMAT706 12" x 2" x 4" diameter
J. FWMAT701 8" x 1" x 4" diameter
FWMAT702 8" x 1" x 4.5" diameter
K. FWMAT703 7" x 1" x 4" diameter
L. FWMAT704 6" x 1" x 4" diameter
FWMAT705 6" X 1" X 3" diameter



M. LIFECYCLE PEDAL STRAPS

Sold in pairs only. 1/2 lb
LC955



SEAT BELTS

N. Plastic Buckle 2 lbs
FW150
O. Heavy duty metal coated w/ hard plastic 2 lbs
FW155



BIKE SEATS

Additional seats available at fullcirclepadding.com

P. WIDE EXERCISE SADDLE WITH SPRINGS

Fits 7/8" round seat post. 5 lbs
LC926

Q. LIFECYCLE 9500 MOLDED SEAT

Attaches with 4 bolts to seat post. 5 lbs
LC930

R. PRECOR C846 SEAT

Molded Rubber Bike Seat with 7/8" Post Clamp. Fits Lifecycle and Precor C846 and C846I 5 lbs
PRE305

S. LIFECYCLE 9500 DELUXE SPRINGLESS SEAT

Attaches with 4 bolts, diamond shape bolt pattern. 5 lbs
LC935 Black
LC935G Gray

T. RECUMBENT BIKE SEATS

Fits Lifecycle 9500, 9100.
LC929 Recumbent Back
LC928 Recumbent Seat

PLASTIC CAPS



A. FWP271 1.25" x 1.25" Plastic Frame Cap
 B. FWP282 1.5" x 1.5" Plastic Frame Cap
 C. FWP269 1.5" x 2" Plastic Frame Cap

D. FWP270 1.5" x 2.5" Plastic Frame Cap
 E. FWP281 1.5" x 3" Plastic Frame Cap

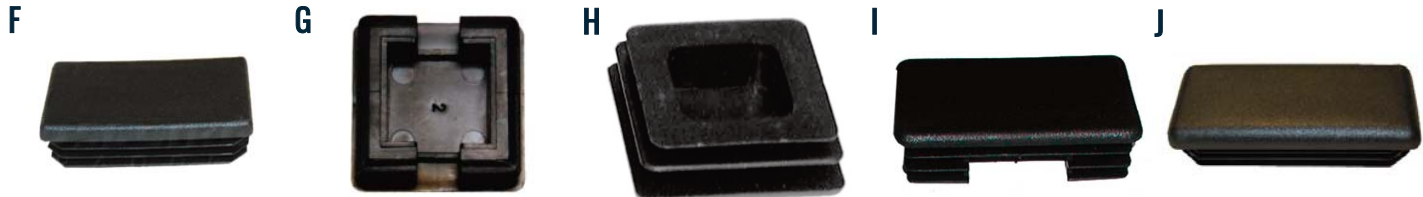

F. FWP266 1" x 2" Plastic Frame Cap
 G. FWP272 1.75" x 1.75" Plastic Frame Cap
 H. FWP280 2" x 2" Plastic Frame Cap

I. FWP283 2" x 3" Plastic Frame Cap
 J. FWP284 2" x 4" Plastic Frame Cap



K. FWP274 2.25" x 2.25" Plastic End Cap
 L. FWP275 2.5" x 2.5" Plastic End Cap
 M. FWP267 1" x 1" Plastic Frame Cap

N. FWP276 3" x 3" Plastic Frame Cap
 O. FWP277 4" x 4" Plastic Frame Cap



P. FWP285 1 1/4" Chrome Frame Cap
 Q. FWMAT607 1" Plastic Mushroom Cap
 R. LF109 Plastic End Cap, 1 5/8" x 1 11/16" Inside Diameter

S. FWP286 1 3/16" Nylon Locking Plug
 T. FWP287 1" Nylon Locking Plug
 U. FWP268 Round Plastic Frame Cap, 1 1/2" outside diameter, 1 1/4" inside diameter



V. FWP289 1 1/4" Nylon Locking Plug
 W. FWP279 3" Round Plastic Frame Cap
 X. FWP288 7/16" Nylon Locking Plug
 Y. LF815 4.5" x 2.5" Large Oval Frame Cap, Life Fitness Signature Series

Z. LF816 2.75" x 1.5" Small Oval Frame Cap, Life Fitness Signature Series
 AA.FWP290 1/4" Nylon Locking Plug

RUBBER CAPS & TIPS



A. CYW150 1 1/2" x 3/4" Rubber Bumper
B. FWMAT604R 2" x 2" Rubber End Cap
C. FWMAT605R 2" x 3" Rubber End Cap



D. FWMAT606R 2" x 2" Rubber Angled End Cap
E. FWP300CP 1 1/2" OD Rubber Tip



F. FWP300 1 7/8" OD Rubber Bumper / Tip
G. FWP300TP 1 7/8" OD Rubber Tip



H. FWP302ER Rubber Bar End Bumper
I. FW191 2" Vinyl Cap



J. NA515 1" Rubber Button Stop
K. FW190 1 1/2" Vinyl Cap
L. NA517 1/2" Mushroom Rubber Stop



M. NA518 3/4" Rubber Bar Stop
N. NA519 7/8" Rubber Bar Stop



O. NA520 1" Rubber Bar Stop
P. NA521 1 1/8" Rubber Bar Stop
Q. NA522 1 1/4" Rubber Bar Stop



R. LF111 Hammer Plate Horn Rubber Bumper
Fits Hammer Plateloaded



S. FWP300RP Plate Horn Rubber Bumper



T. LF100 Rubber Bumper / Tip
Fits 1 3/8" - 1 1/2" Inside diameter pipe



U. HAM215 6" x 2" Hammer Strength Rubber Boot



V. HAM216 6" x 3" Hammer Strength Rubber Boot

POP PINS

A



A. POP PIN SPRING

Spring measures 1 3/8" long with 7/16" opening. Spring will fit all our stock pop pins as well as many others. 1/2 lb
FW130S

B

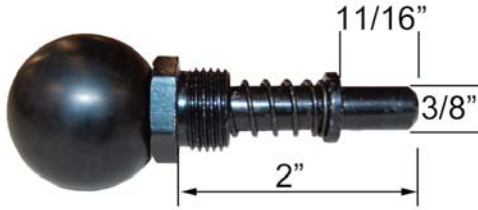

B. 3/8" FINE THREAD POP PIN

3/8" Diameter Pop Pin Assembly with 3/4"-16 Fine Thread Frame Nut 1/2 lb
FW130

C

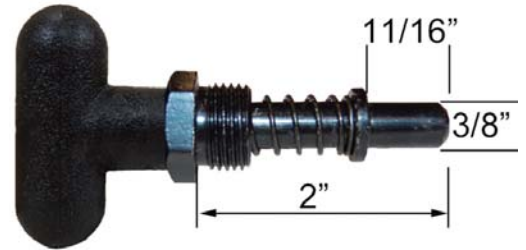

C. 3/8" FINE THREAD POP PIN

3/8" Diameter Pop Pin Assembly with T-Handle Knob & 3/4"-16 Fine Thread Frame Nut, 1/2 lb
FW130T

D



D. 3/8" COURSE THREAD POP PIN

3/8" Diameter Pop Pin Assembly with 3/4"-10 Coarse Thread Frame Nut, 1/2 lb
FW130C

E

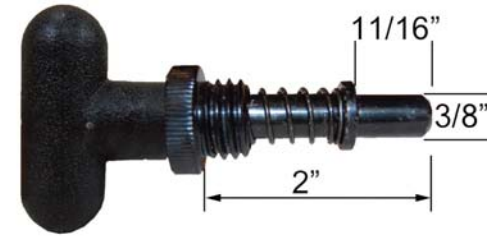

E. 3/8" COURSE THREAD POP PIN

3/8" Diameter Pop Pin Assembly with T-Handle Knob & 3/4"-10 Coarse Thread Frame Nut, 1/2 lb
FW130CT

F

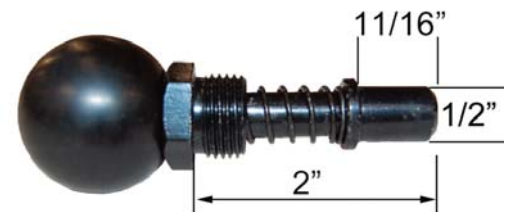

F. 1/2" FINE THREAD POP PIN

1/2" Diameter Pop Pin Assembly with 3/4"-16 Fine Thread Frame Nut, 1/2 lb
FW131

G

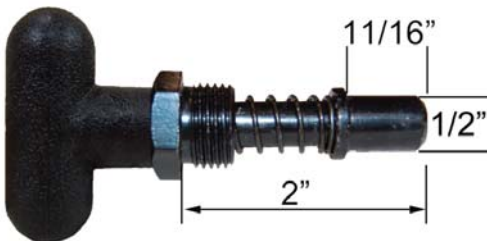

G. 1/2" FINE THREAD POP PIN

1/2" Diameter Pop Pin Assembly with T-Handle Knob & 3/4"-16 Fine Thread Frame Nut, 1/2 lb
FW131T

H



H. 1/2" COURSE THREAD POP PIN

1/2" Diameter Pop Pin Assembly with 3/4"-10 Coarse Thread Frame Nut, 1/2 lb
FW131C

I

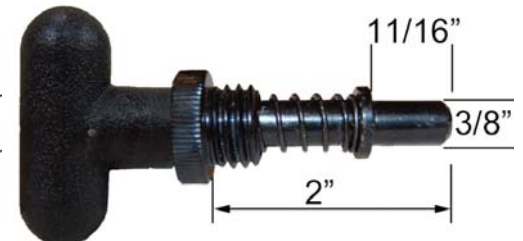

I. 1/2" COURSE THREAD POP PIN

1/2" Diameter Pop Pin Assembly with T-Handle Knob & 3/4"-10 Coarse Thread Frame Nut, 1/2 lb
FW131CT

THREADED KNOBS & SCREW DOWN KNOBS

3/8" KNOBS - MOST COMMON SIZE

- A. FW141T 3/8" T-Handle
- B. FW141 3/8" Ball Knob 1/2 lb
- FW141F 3/8" Fine Thread Ball Knob 1/2lb . .

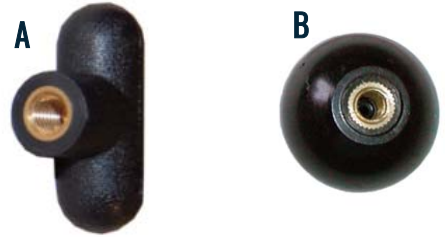

5/16" BALL KNOBS

- FW144 5/16" Ball Knob
- FW144T 5/16" T-Handle
- FW144F 5/16" Fine Thread Ball Knob.

1/4" KNOBS

- FW140 1/4" Ball Knob
- FW140T 1/4" T-Handle

1/2" KNOBS

- FW147 1/2"-13 Ball Knob



C. CYBEX POP PIN KNOB
3/8"-16 Thread Cybex Pop Pin Knob
1/4 lb
CYW311K



D. LIFE FITNESS POP PIN KNOB
3/8"-16 Thread Tulip Style Pop Pin Knob, 1/4 lb
LF584

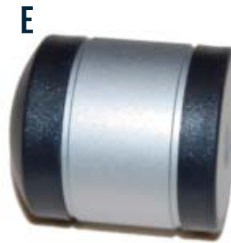

E. LIFE FITNESS POP PIN KNOB
3/8"-16 Thread Signature Series Pop Pin Knob, 1/4 lb
LF800K



F. CYBEX POP PIN KNOB
5/16"-18 Thread Cybex Pop Pin Knob
1/4 lb
CYW102K



G. PRECOR UPRIGHT BIKE POP PIN KNOB
5/16"-18 Thread, Precor C842, C842i, C846, C846i Upright Bike Seat Pop Pin Knob 1/4 lb
PRE311



H. RUBBER BAR END BUMPER
FWP302ER



I. BLUE ANODIZED ALUMINUM PREMIUM KNOB
3/8-16 Threaded
IC600K



- J. FW160 1/2" x 2"
- K. FW15915 3/8" x 1 1/2"
- L. FW1591 3/8" X 1"

SCREW DOWN KNOBS

PULLEYS

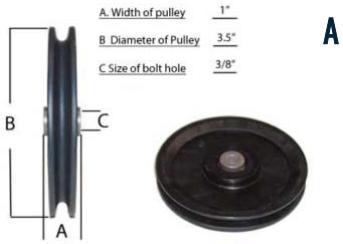

A. 3 1/2" PULLEY, 3/8" HOLE
3-1/2" pulley for 1" frame with 3/8" bolt hole. Can be used with 1/4" or 3/16" cable.
FW35B1H38

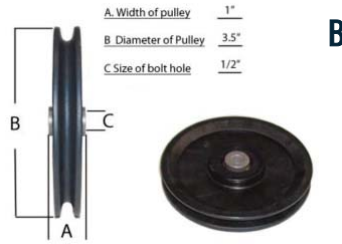

B. 3 1/2" PULLEY, 1/2" HOLE
3 1/2" pulley for 1" frame with 1/2" bolt hole. Can be used with 1/4" or 3/16" cable.
FW35B1H12

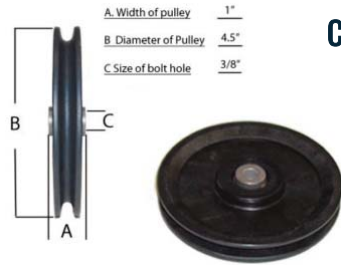

C. 4 1/2" PULLEY, 3/8" HOLE
4 1/2" pulley for 1" frame with 3/8" bolt hole. Can be used with 1/4" or 3/16" cable.
FW45B1H38

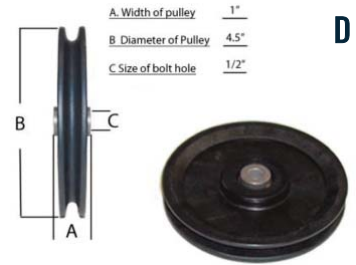

D. 4 1/2" PULLEY 1/2" HOLE
4 1/2" pulley for 1" frame with 1/2" bolt hole. Can be used with 1/4" or 3/16" cable.
FW45B1H12

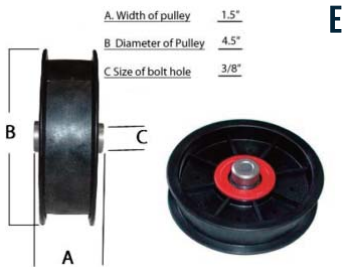

E. 4 1/2" PULLEY FOR BELTING
4-1/2" Pulley for 1 1/2" frame with a 3/8" bolt hole. Can be used with 15/16" belting.
FW45FBB15H38

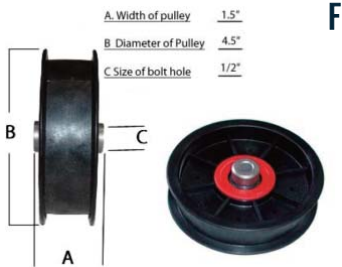

F. 4 1/2" PULLEY FOR BELTING
4 1/2" Pulley for 1-1/2" frame with a 1/2" bolt hole. Can be used with 15/16" belting
FW45FBB15H12

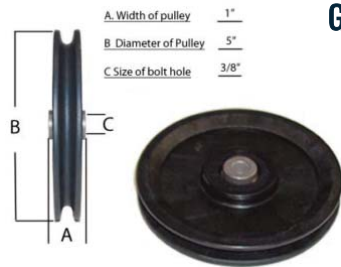

G. 5" PULLEY, 3/8" HOLE
5" Nylon Pulley for 1" frame with 3/8" bolt hole. Can be used with 1/4" or 3/16" cable.
FW51B1H38

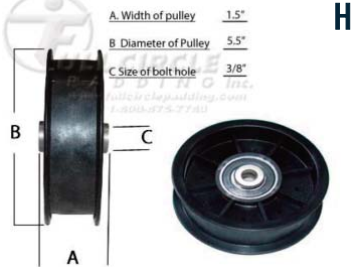

H. 5 1/2" PULLEY FOR BELTING
5 1/2" Pulley for 1-1/2" frame with a 3/8" bolt hole. Can be used with 15/16" belting.
FW55FBB15H38

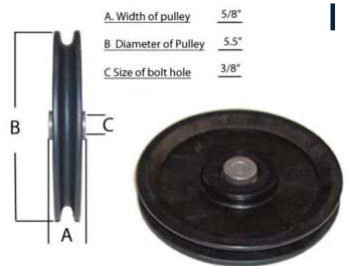

I. 5 1/2" PULLEY, 5/8" HOLE
5 1/2" Pulley for a 5/8" frame with a 3/8" bolt hole. Can be used with 1/4" or 3/16" cable.
FW55B58H38

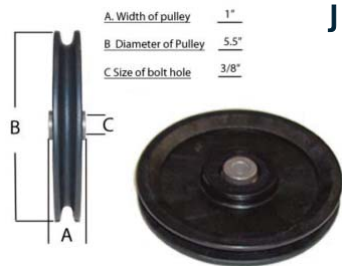

J. 5 1/2" PULLEY, 3/8" HOLE
5-1/2" Nylon pulley for a 1" frame with a 3/8" bolt hole. Can be used with 3/16" cable only.
FW55B1H38

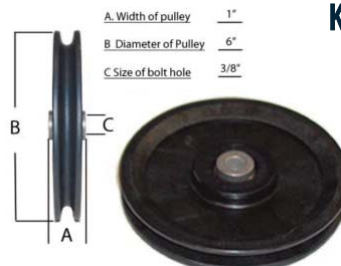

K. 6" PULLEY, 3/8" HOLE
6" Nylon Pulley for a 1" frame with 3/8" bolt hole. Can be used with either 1/4" or 3/16" cable.
FW60B1H38

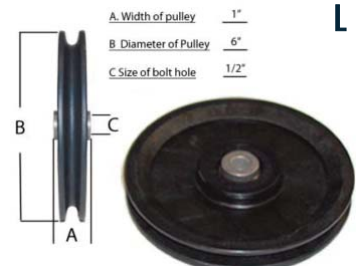

L. 6" PULLEY 1/2", HOLE
6" Nylon Pulley for a 1" frame with 1/2" bolt hole. Can be used with either 1/4" or 3/16" cable.
FW60B1H12

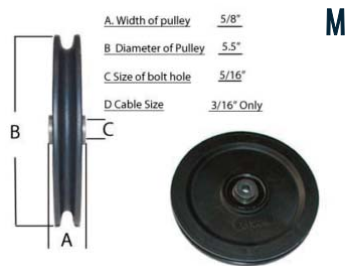

M. UNIVERSAL PULLEY - FOR OLDER UNIVERSAL EQUIPMENT ONLY
Fits 3/16" Cable only
UN720A

N. CABLE GUIDE

All custom sizes are available. Need diameter of pulley, hole size and length from outside of frame to outer edge of pulley. 1/2 lb
FW152



MEASUREMENTS NEEDED FOR PULLEYS

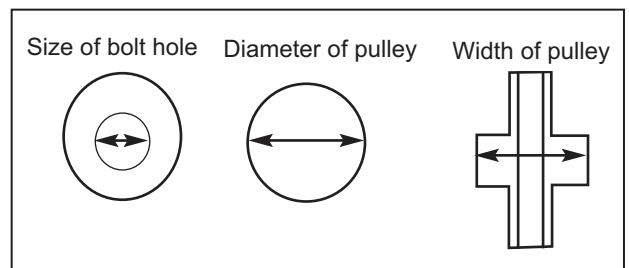

A



B



C



D



E



TIP

TO DETERMINE WHICH KIND OF BELTING YOU NEED LOOK AT THE END OF THE BELT.

- If you see round “fibers” running through it and horizontal lines is the Kevlar Belting. (BM500B)
- If the belt is rigid, and looks like three flat pieces sandwiched together it is the polyamide belting. (BM500A)
- Measure the width.

A. 15/16” KEVLAR BELTING

Standard belting used in the fitness industry. Fits on the following equipment: Cybex, VR2, B Master, Nau-tilus, Magnum, Flex and others. Sold by the foot or by the 100 foot roll.

BM500B 15/16” Kevlar belting by the foot

BM500BROLL 100 ft roll 15/16” Kevlar Belting

B. 15/16” POLYAMIDE BELTING

More rigid than the kevlar belting, used in high use areas. Fits the same equipment as kevlar belting. Use on lat pulldowns, low rows and leg presses. Sold by the foot or the 100 foot roll.

BM500A 5/16” polyamide belting

BM500AROLL 100 ft roll 15/16” Polyamide Belting

3/4” KEVLAR BELTING (not pictured)

Standard belting used in the fitness industry. Fits Pacific, Stairmaster and others. Sold by the 100 foot roll only

BM500CROLL

C. 5MM BLACK TITAN CORD

Used on some Body Masters, Magnum and Atlantis equipment. Tensile Strength: 3100 lbs. Sold per foot. This item is not returnable.

BM590

D. ANTI SLIP GRIP TAPE

This is a high quality anti-slip tape. It has a self adhesive backing making it a great choice for foot platforms on your fitness equipment or any where you might need a anti-slip tape (Floor or indoor ramp ect.)

2” TAPE

FWT2CASE Sold by the case only(6 - 60' rolls)

4” TAPE

FWT4 By the foot,

FWT4ROLL 60' Roll

FWT4ROLLE Economy tape, 60' roll

6” TAPE

FWT6 By the foot

FWT6ROLL 60' Roll

FWT6ROLLE Economy tape, 60' roll

12” TAPE

FWT12 By the foot

FWT12ROLL By the roll

FWT12ROLLE Economy tape 60' roll

E. 3M SAFETY WALK RUBBER GRIP TAPE

For barefoot or shoe-traffic areas. Non-mineral, medium-textured, slip resistant vinyl surface. Resilient surface and durable adhesive provide long-lasting performance. Applications include locker rooms, around hot tubs and pools, boats, personal watercraft, water skis, exercise equipment, and conveyers.

2” RUBBER TAPE

FWTR3M02 By the foot

FWTR3M02ROLL By the 60' Roll

4” RUBBER TAPE

FWTR3M04 By the foot

FWTR3M04ROLL By the 60' Roll

6” RUBBER TAPE

FWTR3M06 By the foot

FWTR3M06ROLL By the 60' Roll

12” RUBBER TAPE

FWTR3M12 By the foot

FWTR3M12ROLL By the 60' Roll

PROTECTIVE GUARDS

HOW TO MEASURE FOR PROTECTIVE GUARDS

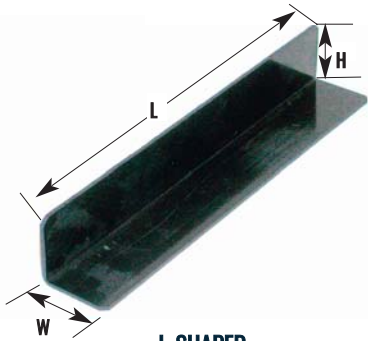

L-SHAPED

Height + Width x Length = total square inches



FLAT

Width x Length = total square inches

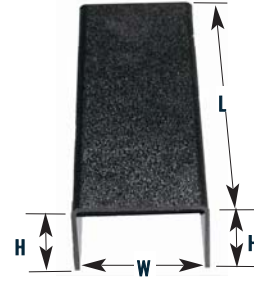

U-SHAPED

Height + Width + Height x Length = total square

There is a minimum charge of \$8.25 per piece for protective guards.

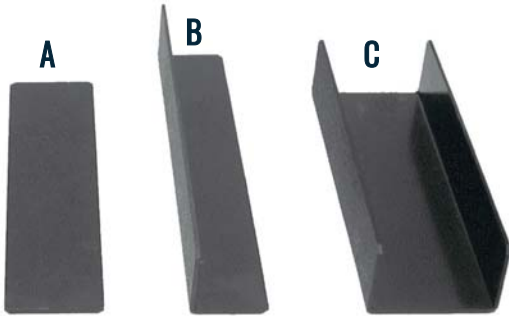

PROTECTIVE GUARDS

Use for frame and plate protection, replaces grip tape. Includes double sided tape. Self taping screws available upon request. Any custom size is available.

A. 3/16" THICK TEXTURED BAR & PLATE GUARD

Use to protect your frame from chips and scratches caused by plates, bars and cable attachments. Textured finish. Measurements needed: Width x Length = total square inches

FWFABS Sold per square inch

1/8" THICK TEXTURED FOOT GUARDS

Use to replace anti-slip tape which wears out more quickly. Measurements needed: Width x Length = total square inches

FWTABS Sold per square inch

B. L-SHAPED GUARDS

3/16" thick. Measurements needed:

Height + Width x Length = total square inches

FWLABS Sold per square inch

C. U-SHAPED GUARDS

3/16" thick ABS custom formed to your equipment. Easy application. Sold by the square inch. Black only. Measurements needed:

Height + Width + Height x Length = total square inches

FWUABS Sold per square inch

ROUND PROTECTIVE GUARDS

Most commonly used for barbell and plate racks. Any custom size is available.

D. 1" ROUND PLASTIC GUARD

Use as peg guards on barbell racks or as heavy duty bar holder guards. Rigid plastic will not bend.

FWR1ABS Sold by the inch

E. 3/4" ROUND PLASTIC GUARD

Use as peg guards on barbell racks or as heavy duty bar holder guards. Rigid plastic will not bend.

FWR75ABS Sold by the inch

F. 3/8" ROUND PVC TUBE

Use for bar holder guards or where a bendable guard is needed.

FWR38PVC Sold by the inch



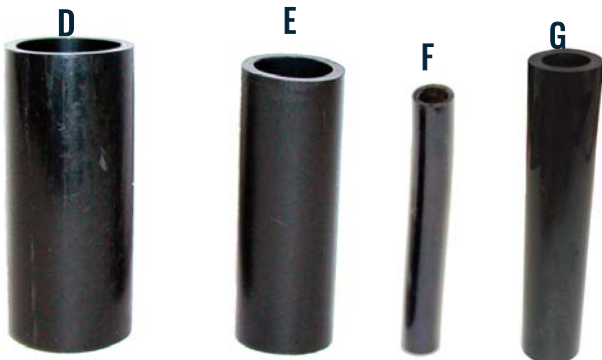

G. 1/2" ROUND PVC TUBE

Use for bar holder guards or where a bendable guard is needed.

FWR5PVC Sold by the inch



To determine the size grip you need:

-  Measure the length and diameter of the bar / shaft
-  Is it an open end or closed end.
-  For grip installation use a small amount of hairspray. It's slippery when wet. Sticks when dry.
-  Any of our grips can be cut down to the exact size you need.

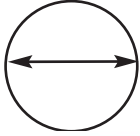

Diameter is a straight line passing through the center of the bar / shaft.



Hard Rubber Grip



PVC Grip



Foam Grip

Go to www.FullCirclePadding.com for our expanded selection of grips

5/8" GRIP

GRP585 5/8" X4 3/4" Hard Rubber Grip

3/4" GRIPS

GRP340 3/4" x 6" Foam Grip
GRP340R 3/4" x 5" Hard Rubber Grip
GRP345PVC 3/4" x 8" Closed End PVC Grip
GRP341 3/4" x 12 1/2" Foam Grip

7/8" GRIPS

GRP7804PVC 7/8" x 4" PVC Foot Grip
GRP785 7/8" x 5 1/4" Hard Rubber
GRP7818 7/8" x 8" Foam Grip
GRP781 7/8" x 15" Foam Grip

1" GRIPS

GRP100R 1" x 5" Hard Rubber Grip
GRP100W 1" x 4 1/2" Grip w/ flange
GRP100PVC 1" x 8" PVC Grip
GRP113PVC 1" x 12" PVC Grip
GRP115C 1" x 15" Foam Grip
GRP118PVC 1" x 18" PVC Grip
GRP131PVC 1" x 24" PVC Grip
GRP130PVC 1" x 30" PVC Grip

1 1/8" GRIPS

GRP140 1 1/8" x 14 1/2" Foam Grip
GRP135PVC 1 1/8" x 32" PVC Grip

1 1/4" GRIPS

GRP154 1 1/4" x 5 1/4" Hard Rubber Grip
GRP1566 1 1/4" x 6" Open End Grip
GRP156PVC 1 1/4" x 12" PVC Grip
GRP150 1 1/4" x 14" Foam Grip
GRP15528PVC 1 1/4" x 28" PVC Grip
GRP155PVC 1 1/4" x 36" PVC Grip

1 1/2" GRIPS

GRP1625 1 1/2" x 5" Open End Grip
GRP162525 1 1/2" x 5 1/4" Open End Grip
GRP16255 1 1/2" X 5 1/2" Open End Grip
GRP1627 1 1/2" x 7" Open End PVC Grip
GRP166 1 1/2" X 7 1/2" Foam Grip
GRP1628 1 1/2" x 8" Open End Grip
GRP160PVC 1 1/2" x 30" PVC Grip

1 5/8" GRIPS

GRP170 1 5/8" x 20" Foam Grip

1 3/4" GRIPS

GRP175PVC 1 3/4" x 17" PVC Grip



A B C D

ALUMINUM GRIP CAPS

- A. NA495** 3/4" Aluminum Grip Cap
- B. NA483** 7/8" Tapered Aluminum Grip Cap with set screws
- C. NA500** Aluminum Grip Cap
- D. NA505** 1 1/4" Aluminum Grip Cap

NOT PICTURED

- NA501** 1" Aluminum Grip Collar
- NA484** 1" Tapered Aluminum Grip Cap with Set screws
- NA486** 1 1/4" Tapered Aluminum Grip Cap with Set Screws
- NA487** 1 1/2" Tapered Aluminum Grip Cap with Set Screws



E. BAR WRAP

Cork grip bar wrap. Two 6' lengths covers 36" on a 1" diameter bar. 1/2 lb
GRP800

CABLE SUPPLIES

To order custom cables please use the instructions on "How To Measure Custom Cables" on page 36. If your cable does not match any of the ones pictured please call. It is extremely important that you follow these instructions to get an accurate measurement. **Custom Cables are NON REFUNDABLE.** If you have any questions please call.

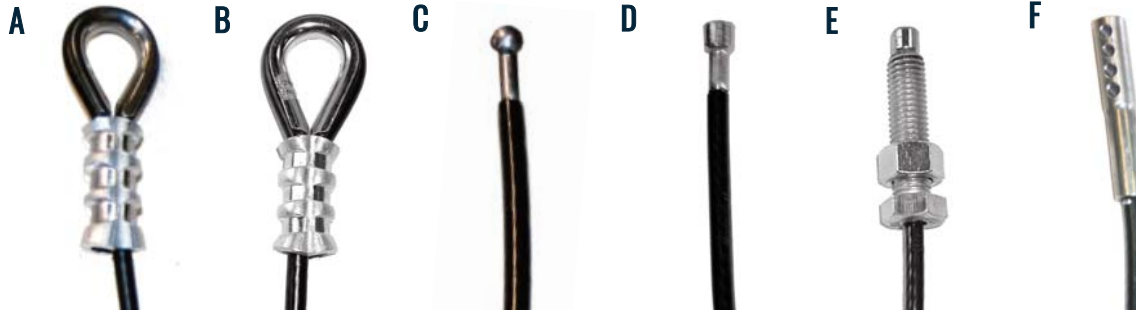

3/16" CABLE

1/8" CABLE COATED TO 3/16"

A. 3/16" BLACK CABLE WITH SLEEVE AND THIMBLE (PICTURED)

- FW105 1/8" Cable coated to 3/16" - Black
- FW105RL-B 3/16" Roll 250 ft- Black

1/4" CABLE

3/16" CABLE COATED TO 1/4"

B. 1/4" BLACK CABLE WITH SLEEVE AND THIMBLE (PICTURED)

- FW100B 3/16" Cable coated to 1/4" - Black
- FW100RL-B 1/4" Roll 250 ft - Black

BALL & SHANK CABLES

Sold in precut lengths. Can be cut to size. Please follow custom cable instructions.

C. 3/16" BALL AND SHANK CABLE

- FW12810 10 foot cable
- FW12815 15 foot cable
- FW12820 20 foot cable
- FW12825 25 foot cable
- FW12830 30 foot cable
- FW12835 35 foot cable
- FW12838 38 foot cable

D. 1/4" BALL AND SHANK CABLE

- FW12710 10 foot cable
- FW12715 15 foot cable
- FW12720 20 foot cable
- FW12730 30 foot cable
- FW12735 35 foot cable

E. 1/4" Ball and shank cable sold above with 1/2" threaded cable bolt

MAKE YOUR OWN CYBEX CABLES

F. The cables below are shipped with one machine end. Customer will need to finish cable on-site.

- CYW010 10' Cable with machined end
- CYW015 15' Cable with machined end
- CYW025 25' Cable with machined end



3/16" CABLE PARTS

- G. FW108 Cable Sleeve
- H. FW107 3/16" Cable Thimble
- FW106 3/16" Cable Sleeve & Thimble - 1 set
- FW106S 3/16" Cable sleeve & thimble -10 sets
- I. FW120WSS Nylon Cable Ball 1 1/4" O.D
- FW120TEN Set of 10 Nylon Cable Balls
- FW120HUNDRED Set of 100 Nylon Cable Balls

1/4" CABLE PARTS

- J. FW103 1/4" Cable Sleeve
- K. FW102 1/4" Cable Thimble
- FW101 1/4" Cable Sleeve & Thimble - 1 set
- FW120WSS Nylon Cable Ball 1 1/4" O.D with set screw
- FW101S 1/4" Cable Sleeve & Thimble -10 sets

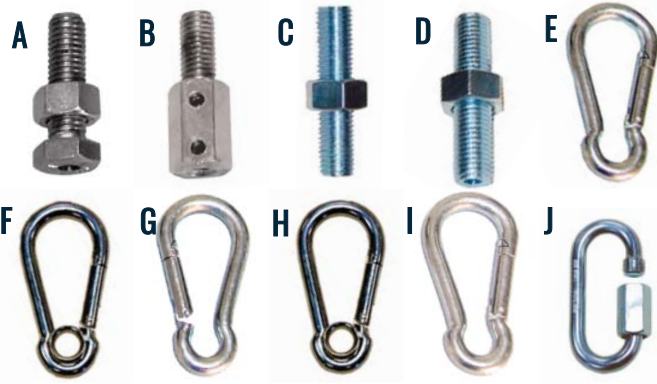

CABLE ACCESSORIES

- A. **FW121** 13 threaded Cable Bolt for use with ball & shank end cables
- FW12138** 3/8" Threaded Cable Bolt
- B. **FW121CC** Cable / Plate Connector 1/2" - 13"
- C. **FW121LF** 9/16" - 12 X 2 3/4" Threaded stud with nut
- D. **FW121M** M16-2 x 70 mm Threaded stud with nut
- E. **HEAVY BAG CLIP**
Specification: 1/2" Diameter, 1" Opening, 5-5/16" Inside length, 900 lb Weight Capacity. (Note: Clip will not fit most cable attachments)
- FW816**
- F. **FW122WG** Small Snap clip with grommet (almost theft proof)
- G. **FW122** Small Snap Clip 3" w/ zip tie
- H. **FW124WG** Large Snap Clip 4" with grommet (almost theft proof)
- I. **FW124** Large Snap Clip 4" w/ zip tie
- FW123** X Small Snap Clip 2 1/2" w/ zip tie (not pictured)
- J. **FW126** 5/16" Quick Link



CABLE CUTTERS & CRIMPERS

ALL TOOLS ARE FINAL SALE AND ARE NOT RETURNABLE

K. CABLE CUTTERS

Cutters have hardened steel blades and spring loaded handle. Imported. This item is final sale and is not returnable. 2 lb

TL145

L. 3/16" MULTI CAVITY CRIMPERS WITH CUTTER

Use to crimp 3/16" sleeves, 3/16" and 1/4" stops onto cable. Has cutter built in. 6 lbs

TL135

M. 1/4" MULTI CAVITY CABLE CRIMPERS

Save money and downtime on your equipment by making your own cables. Works with 5/32", 1/4" and 5/16" cable. Crimpers measure 30" 10 lbs

TL140

Having trouble keeping snap clips? Try this:



1. Attach snap clip to machine.

2. Wrap zip tie around narrowest part of clip and attach.

3. Clip free end off.



N. 3/16" CABLE HARDWARE KIT

This kit includes all of the hardware you need to make your own 3/16" cables. 8 lbs Kit includes:

- 60 ft - 3/16" Black Cable
- 12 - Small Snap Clips
- 12 - 3/16" Cable Thimbles
- 12 - 3/16" Cable Sleeves
- 12 - Cable Balls with Set Screw
- 1 - 3mm Allen Key (for set screw in cable ball)

Kit **DOES NOT** include cable cutters or crimpers. Sold separately.

FW105CK

1/4" CABLE HARDWARE KIT

This kit includes all of the hardware you need to make your own 1/4" cables. 8 lbs Kit includes:

- 60 ft - 1/4" Black Cable
- 12 - Small Snap Clips
- 12 - 1/4" Cable Thimbles
- 12 - 1/4" Cable Sleeves
- 12 - Cable Balls with Set Screw
- 1 - 3mm Allen Key (for set screw in cable ball)

Kit **DOES NOT** include cable cutters or crimpers. Sold separately

FW100CK

CUSTOM CABLES

Ordering custom cables is now easier than ever! Head over to the computer or grab your phone, iPad or tablet, the cable you need replaced, go to the all new FullCirclePadding.com and click on Cable Builder. Then follow the simple steps shown below to place your order. If you have any questions please call us at 1-800-875-7780.

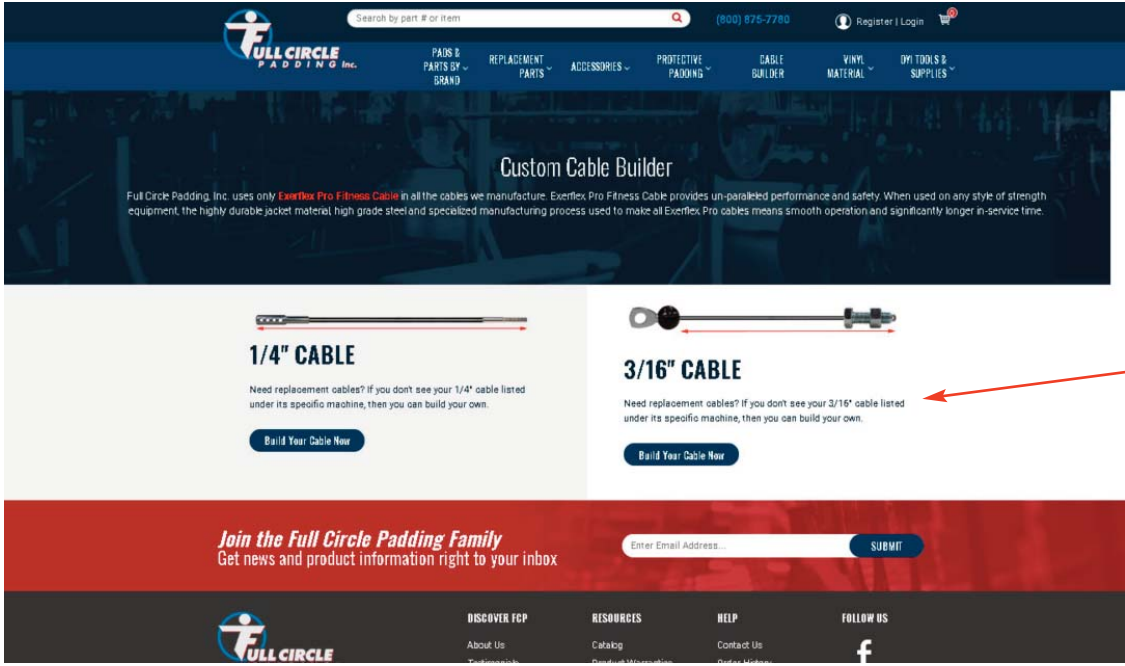

CHOOSE YOUR CABLE SIZE.

Is your cable 1/4" cable or 3/16" cable?

HOME > 1/4" CABLE END > 1/4" CABLE



There are no alternate images available for this product.

1/4" CABLE

PART NUMBER: CB14
 ☆☆☆☆ (0) | WRITE REVIEW

End One: FW826 1/4" Cable Sleeve & Thimble with 1-3/4" Ball Clear

End Two: FW826 1/4" Cable Sleeve & Thimble with 1-3/4" Ball Clear

Total Price: \$ 41.98

\$15.00 labor charge is added per cable.

Cable Name:

Length: Inches Fractions:

QTY: **ADD TO CART**

Important Notes: All pads and cables are made to order and therefore non-returnable. Please contact customer service with any questions prior to adding to cart.

Pad orders are shipping in 16-18 business days. Large orders may take longer. Expedited shipping may be chosen during checkout, however pad orders will ship in our current lead time

CHOOSE YOUR ENDS

As you choose your cable ends the picture on the left changes to show the measurement needed. Measure your cable carefully and measure twice just to be sure it is correct.

ENTER CABLE INFORMATION

Name your cable for easy identification.

Enter the cable length in the space provided and the total price per cable will be shown

QUANTITY & ADD TO CART

Enter the quantity of that cable that you need and add to cart.

is://fullcirclepadding-design.idevdesign.net/1/4-cable/#

Custom cut cables are non-returnable. Due to the magnitude of replacement cables and manufactures' we work with every cable is made to order. Full Circle Padding, Inc. is not responsible for incorrectly ordered cable. Manufacturers may have several lines of equipment with different cables. If additional assistance is needed, please contact us directly at: 1-800-875-7780

WEIGHT STACK PINS

ALL OF OUR PINS HAVE A HOLE DRILLED IN THEM TO EASILY ATTACH A SHOCK CORD AT ANY TIME.

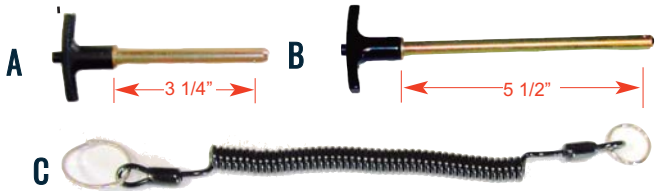

CYBEX, NAUTILUS, PARAMOUNT 3/8" LOCKING PINS (FOR ADDED SAFETY)

3/8" LOCKING PINS

All measurements are locking spaces, not length of pin. All heavy duty cords come with easy attachment loose leaf ring.

- A. **FW705** 3/8" x 3 1/4" Push Button Lock Pin
- FW705SC** 3/8" x 3 1/4" Lock Pin w/ HD Cord
- B. **FW707** 3/8" x 5 1/2" Push Button Lock Pin
- FW707SC** 3/8" x 5 1/2" Push Button Lock Pin w/ HD Cord
- C. **FW156** Heavy Duty Shock Cord

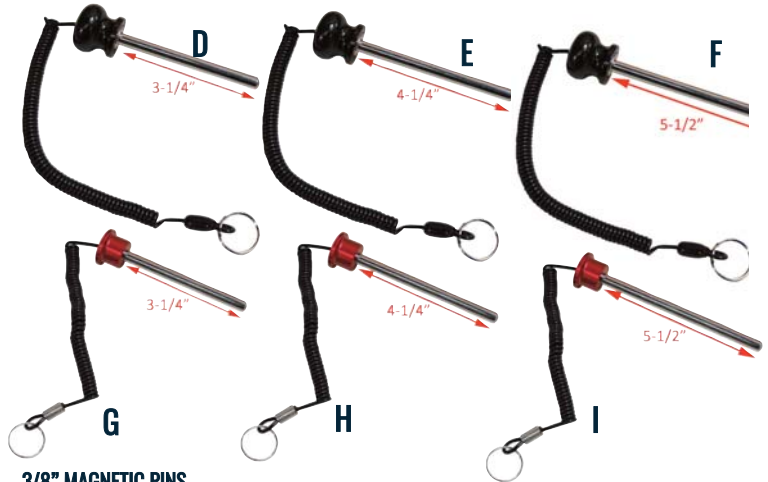

3/8" MAGNETIC PINS

Magnetic weight stack pins have an attached cord to keep the pin with the equipment and are available with either a black or red aluminum knob.

BLACK KNOB

- D. **FW701** 3/8" x 3 1/4" pin with black knob
- E. **FW702** 3/8" x 4 1/4" pin with black knob
- F. **FW703** 3/8" x 5 1/2" pin with black knob

RED KNOB

- G. **FW731** 3/8" x 3 1/4" pin with red knob
- H. **FW732** 3/8" x 4 1/4" pin with red knob
- I. **FW733** 3/8" x 4 1/2" pin with red knob

UNIVERSAL PIN

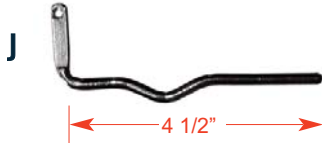

J. UNIVERSAL PIN

- FW715** 5/16" x 4 1/2" pin
- FW715SC** 5/16" x 4 1/2" pin w/ HD cord
- FW156** Heavy duty shock cord

CYBEX MODULAR - BASIC PIN 3/8" x 3 1/2"

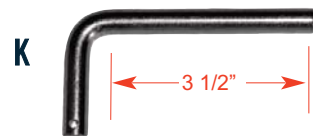

K. 3/8" BASIC PIN

- 3/8" x 3 1/2" Fits Cybex Modular
- FW711** Pin only
- FW711SC** Pin with shock cord

BODYMASTER, FREE MOTION & GROUND ZERO

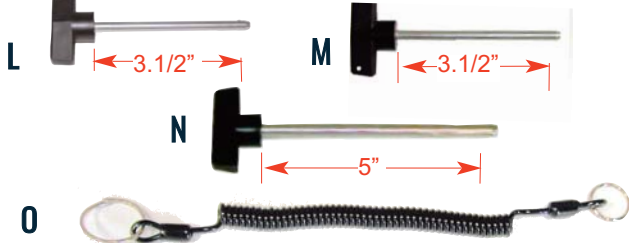

1/4" & 5/16" T HANDLE PINS

All of these pins are **American Made** with zinc plated steel and polypropylene handles. All measurements are locking spaces. 1/2 lb

- L. **FW713** 1/4" x 3 1/2" Weight Pin
- FW713SC** 1/4" x 3 1/2" Weight Pin w/ HD Cord
- M. **FW714** 5/16" x 3 1/2" Weight Pin
- FW714SC** 5/16" x 3 1/2" Weight Pin w/ HD Cord
- FW716** 5/16" x 5" Weight Pin
- N. **FW716SC** 5/16" x 5" Weight Pin w/ HD Cord
- O. **FW156** Heavy Duty Shock Cord

CYBEX, HAMMER, ICARIAN, LIFEFITNESS, NAUTILUS & OTHERS

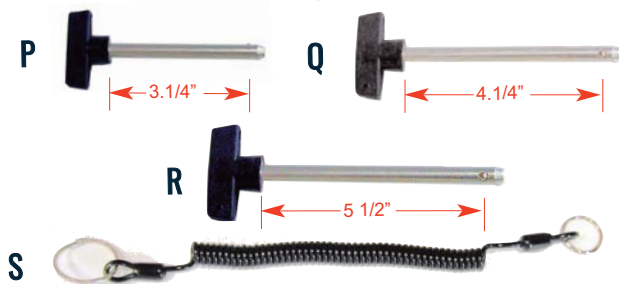

3/8" T HANDLE PINS

All of these pins are **American Made** with zinc plated steel and polypropylene handles. All measurements are locking spaces.

- P. **FW708** 3/8" x 3 1/4" T-handle Pin
- FW708SC** 3/8" x 3 1/4" T-handle Pin w/ HD Cord
- Q. **FW709** 3/8" x 4 1/4" T-handle Pin
- FW709SC** 3/8" x 4 1/4" T-handle Pin w/ HD Cord
- R. **FW710** 3/8" x 5 1/2" T-handle Pin
- FW710SC** 3/8" x 5 1/2" T-handle Pin w/ HD Cord
- S. **FW156** Heavy Duty Shock Cord
- NAUTILUS 2ST SIDE WEIGHT STACK (not pictured)**
- NA692** 1/4" x 2 1/2"
- NA692NASC** 1/4" x 2 1/2" w/ Mini Cord

CLEANERS

A. GENERAL PURPOSE SPRAY ADHESIVE

General Purpose Adhesive is the best way to make permanent or temporary bonds on most surfaces. It is also water resistant. For use on Foam Rubber, Urethane, Foam, Glass, Cardboard and Cloth. 12 oz. can
TL196

B.ZEP 45NC PENETRATING LUBRICANT

Zep 45 NC contains a solvent to remove accumulations of grease and grime from the surface, allowing contact with the lubricating protective film to provide long lasting lubrication to moving parts.. It penetrates rapidly to loosen parts that are frozen due to wear, corrosion, heavy grease or grime build up. Excellent for use on any surface that slips, slides, rubs, rolls, moves, turns, twists or pivots.2 lbs
TL191



D



D. EXERCISE EQUIPMENT CLEANER FORMULA 50

A heavy-duty, non-toxic biodegradable cleaner and degreaser. It is designed for professional and general fitness cleaning without harsh fumes or other hazards. Concentrated. Use as directed. 1 Gallon

- CLEEC1** 1 Gallon
- CLEEC14** 4 Gallon Case
- CLEEC1Q** 1 Quart

E



E. VINYL POLISH

Restores and beautifies vinyl to its original condition. Also helps to protect against further penetration of salt and sweat. We recommend applying it once a month. Use sparingly, a little bit goes a long way.

- CLVP1** 1 Gallon
- CLVP1Q** 1 quart
- CLVP1P** 16 oz

F. LEMONEX VINYL CLEANER

A fresh lemon scent cleaner that disinfects, deodorizes and sanitizes. This multipurpose cleaner is perfect for cleaning vinyl as well as locker rooms and floors. It has been diluted but can be diluted more. One gallon will make two gallons if diluted.

- CLVC1** 1 Gallon
- CLVC14** 4 Gallon Case
- CLVC1Q** 1 Quart

F



G. HEAVY DUTY INDUSTRIAL SPRAY BOTTLES

32 oz. Heavy Duty Industrial Plastic Spray Bottles for use with any of our cleaners. Chemical resistant and fully adjustable. Spray Bottles base measures 3-3/8" and will fit in most cleaning stations or bottle holders.

CLSB

GALLON JUG

(Not Pictured) Heavy duty industrial plastic.

CLGJ

G



H



H. GYM VALET

GymValet™ is an easy-to-install bottle and towel holder that gives exercisers convenient access to fitness equipment cleaning and sanitizing supplies. GymValet's unique connection system permits the holder to be attached directly to virtually all equipment frame shapes (round, square, rectangular, or elliptical), angular orientations (from vertical to horizontal) and circumferences with no slipping and sliding. It can accommodate a round bottle up to 32 oz and can easily be repositioned or relocated as well as mounted onto walls. A multi-position rounded hook assembly optimizes towel access. The 5" wide by 6" deep unit can also double as a handy storage container for personal drink bottles and towels. The Hook and Loop Attachment straps can be cut to desired length if needed.

- 0GYMVAL-DS** 1 Gym Valet
- 0GYMVAL-2-DS** Box of 2 Gym Valets
- 0GYMVAL-4-DS** Box of 4 Gym Valets
- 0GYMVAL-10-DS** Box of 10 Gym Valets
- 0GYMVAL-16-DS** Box of 16 Gym Valets

All products on this page are shipped direct from the manufacturer.



FLEX DISINFECTANT WIPES

Flex Wipes disinfectant is a one step cleaner, disinfectant and deodorizer. The antibacterial formula starts killing bacteria on contact. FLEX WIPES Disinfectant Wipes are effective against:

Bacteria

Staphylococcus aureus - Community Associated Methicillin-Resistant, [CA-MRSA] [NRS384] [USA300] Staphylococcus aureus - Community Associated Methicillin-Resistant, [CA-MRSA] [NRS123] [USA400], Staphylococcus aureus (Staph), Salmonella enterica (Salmonella), Enterococcus faecalis- Vancomycin Resistant [VRE], Escherichia coli [E. coli], ESBL Escherichia coli - [Extended spectrum beta-lactamase producing E. coli], Klebsiella pneumoniae [Klebsiella], Legionella pneumophila, Burkholderia cepacia, Salmonella schottmuelleri [Salmonella], Salmonella typhi [Salmonella], Serratia marcescens [Serratia], Shigella dysenteriae [Shigella], Staphylococcus aureus-Vancomycin Intermediate Resistant - [VISA], Streptococcus pyogenes [Strep] [a cause of scarlet fever], Vibrio cholerae

Viruses:

Rotavirus (Diarrhea-causing virus), Hepatitis B Virus [HBV], *Hepatitis C Virus [HCV], Herpes Simplex Virus Type 1 Herpes Simplex Virus Type 2, HIV-1 [AIDS Virus], Human Coronavirus, Influenza Type A Virus / Brazil [Influenza], Norwalk Virus [Norovirus], Respiratory Syncytial Virus [RSV], SARS Associated Coronavirus [SARS] [cause of Severe Acute Respiratory Syndrome], Vaccinia Virus [Pox Virus]

Animal Viruses:

Avian Influenza A [H5N1], Avian Influenza A [H3N2], Avian Infectious Bronchitis Virus, Canine Distemper Virus, Feline Calicivirus, Newcastle's Disease Virus, Pseudorabies Virus

Fungi:

Aspergillus niger Trichophyton mentagrophytes [the Athlete's Foot Fungus] [A cause of Ringworm of the foot]



Active Ingredients:

Octyl decyl dimethyl ammonium chloride 0.0909%, Dioctyl dimethyl ammonium chloride 0.0364%, Didecyl dimethyl ammonium chloride 0.0545%, Alkyl (C14, 50%; C12, 40%; C16, 10%), dimethyl benzyl ammonium chloride 0.1212%; Other Ingredients: 99.6970%, Total 100.0000%, Includes weight of absorbent wipe.

A. FLEX WIPES - BUCKETS

010800-DS 2 Buckets, 800 8" x 6" wipes per bucket

B. FLEX WIPES - REFILLS

010801-DS 2 Refills, 800 8" x 6" wipes per bucket

C. CLEANING WIPES - BUCKETS

Super strong light use towelette for cleaning and freshening high traffic areas. 4 buckets with 900 - 6" x 8" wipes per bucket. (Replaces Kleen Machine Original towelettes & Kleen Machine All surface towelettes) 1 carton CLKM800B4

D. CLEANING WIPES REFILLS

Super strong light use towelette for cleaning and freshening high traffic areas. 4 refills with 900 6" - 8" wipes per bucket. Replaces Kleen Machine Original towelettes & Kleen Machine All surface towelettes) 1 carton CLKM800R4



E. KLEEN MACHINE STAINLESS STEEL FLOOR STAND

This High Line all stainless steel stand is a great solution for dispensing FLEX WIPES. 36" tall, 12" in diameter and weighs 20 lbs. This stand is durable enough for the most demanding environment of any fitness facility. The stand is designed to work with the dispensing bucket for ease of dispensing for your clients. The top simply lifts off to allow for easy changing of the refills, also includes an integrated waste basket opening and a rear trap door to easily change out trash liners.

012000-DS

F. WALL MOUNTED TOWEL DISPENSER

Wall mounted dispenser for FLEX WIPES disinfectant wipes refill rolls and KLEEN-Machine equipment wipes. This is a cost effective yet durable dispensing option for high traffic areas in schools, gyms, nursing homes and other facilities. Easy to mount and easy to clean. 8lbs.

012001-DS

G. PRE-MOISTENED FACILITY WIPES

Pre-moistened facility wipes are ideal for gyms & athletic clubs. Cleans & deodorizes all surfaces. Each case contains 2 rolls of 800 center-pull towels. Each towel is 8"X10". Rainforest fragrance.

0WIPE800-DS

H. WALL MOUNT FACILITY WIPE DISPENSER

Ideal for gyms & athletic clubs. Heavy duty plastic. Mounts with towels dispensing up or down. Use with "0WIPE800-DS."

0WIPE DISP-DS

I. STAINLESS STEEL FLOOR WIPE STAND

Help keep your fitness center clean and minimize the spread of germs. The Stainless Steel Wipe Stand is an attractive and durable stand for dispensing wipes that features a center-pull wipe dispenser on top, making it easy to grab wipes with just one hand. Additionally, utilized wipes can be easily discarded into the receptacle through the fixed hole in the front of the stand. While space-efficient with a sleek cylindrical design, this stainless steel stand will blend in seamlessly with the fitness facility.

0WIPE STAND-DS



CLEANING STATION



All Cleaning Station products ship direct from the manufacturer.

C



Hand Sanitizer



Interchangeable nozzles



Shelves



Waste Basket



Wet or Dry Towels



A



B

THE CLEANING STATION

The Cleaning Station is a cost-effective, one-stop cleaning system making it easy for customers and staff to sanitize equipment and stop the spread of contagious bacteria and viruses. The Cleaning Station is a sleek, freestanding unit constructed of durable silver or black ABS plastic. Shipped with the Cleaning Station are one trash receptacle and Clean Holdings Hand Sanitizer dispenser (sanitizer not included). 10" wide x 15.75" deep and 44.5" high

Features:

Wiper Dispenser Holds either dry towels or premoistened towels (not included)

Hand Sanitizer Dispenser - Built in, holds Clean Holdings bio-based hand sanitizer.(not included)

Trash Receptacle - Towels are easily disposed of in the convenient, built-in waste basket.

A. CL10022 Silver

B. CL10020 Black

Ships direct from the manufacturer.



C



D



E



F



G



H



I

J

K

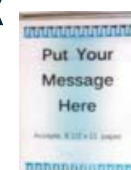

L



C) CLEANING STATION DRY TOWEL

The Cleaning Station 2 ply dry towels are a perfect companion to The Cleaning Station. This towel is economical and practical for a variety of uses. Protects against germs and viruses since users only touch the towel they'll use. Towels are 8" x 11" with 660 towels per roll and 6 rolls per case. 1 case - 2-Ply Dry Towels

CL20015

D) CLEANING STATION PRE MOISTENED WIPES

FDA approved formula antibacterial wipe with a fresh lemon scent. These water based, alcohol free wipes are non-abrasive and lint-free. Tough enough to help prevent the spread of germs on equipment and surfaces, yet gentle on skin. 4 rolls/case, 800 wipes/roll, 8" x 7" towel. 1 case

CL20060

E) CLEAN HOLDINGS DISINFECTANT SOLUTION

The disinfectant is an EPA-registered cleaner that sanitizes, deodorizes and disinfects (kills MRSA). There are 144 concentrated packets which each make 1 quart of cleaner shipped in a small case for convenience, ease of use and storage – just add water. 1 case

CL40010

F) CLEAN HOLDINGS HAND SANITIZER

The Clean Holdings bio-based Hand Sanitizer leaves hands feeling soft and moisturized. This unique, non-irritating formula kills 99.9% of common germs including MRSA. Sold by the case, 8 packs per case. 1000 ml per pack. The Cleaning Station will only accept the Clean Holdings Hand Sanitizer refills. 1 case

CL30030

G) HAND SANITIZER WALL DISPENSER

For use with the Clean Holdings hand sanitizer.

CL30062 Case of 12 dispensers

CL30063 Individual dispenser

H) MARK 11 SPRAY BOTTLES

Wide Mouth spray bottles for use with Clean Holdings disinfectant.

CL40015 1 case of 12 bottles

STARTER PACKS

Whether you just are purchasing The Cleaning station or have been using another product and you want to try something different a starter pack is what you need.

I) DRY TOWEL STARTER PACK

Includes one roll of 2 ply dry towels with 660 towels on the roll. 1 Hand Sanitizer bag, 4 disinfectant packs, 2 spray bottles, 1 dispenser.

CL50010

J) PRE MOISTENED STARTER PACK

Includes 1 roll of pre moistened wipes 1 sanitizer gel bag, 1 dispenser.

CL50020

OPTIONAL ACCESSORIES

K) ACRYLIC SIGN HOLDER

Use with your own printed 8 1/2" x 11" sign.

CL60010

L) CASTERS

Optional casters allow you to easily move the cleaning station wherever it is needed.

CL70010

TOOLS



CABLE CRIMPERS & CUTTERS

A. 3/16" MULTI CAVITY CRIMPERS WITH CUTTER

Use to crimp 3/16" sleeves, 3/16" and 1/4" stops onto cable. Has cable cutter built in.
TL135

B. 1/4" MULTI CAVITY CRIMPER

Save time and money by making your own replacement cables. Works with 5/32", 1/4" and 5/16" cable. Crimpers measure 30"
TL140

C. CABLE CUTTERS

Cutters have hardened steel blades and spring loaded handle. Imported.
TL145

D. HEAVY DUTY SNAP RING PLIERS

For installing and removing snap rings. Patented push button internal and external design. Color coded interchangeable tips. Heavy duty with up to a 2" range.
TL155

E. 1/2" E STYLE RETAINING RING

These rings expand to pass over a shaft usually holding a roller or other machine parts in place. Made of phosphate steel. Fits 1/2" diameter shaft.
FW177

SNAP RINGS

F. FW172B 3/4" Self Lock Retaining Ring

G. FW171 5/8" Snap Ring

H. FW172 3/4" External Retaining Ring

I. FW173 1" External Retaining Ring

J. FW174 1 1/4" External Retaining Ring

K. FW176 1 3/4" External Retaining Ring

FW179 1 1/2" External Retaining Ring (not pictured)

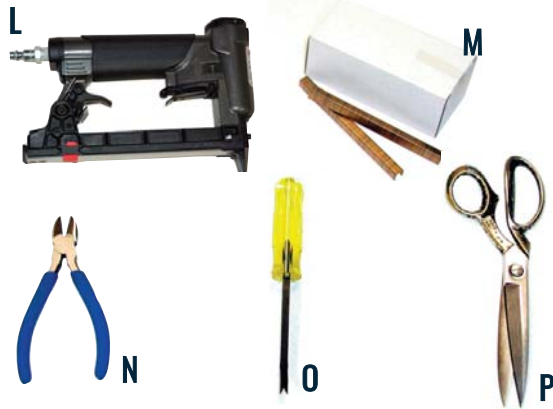

DO-IT-YOURSELF TOOLS

L. AIR STAPLE GUN

TL165

M. BOXED STAPLES - 10,000

TL166

N. STAPLE REMOVER PLIERS

TL180

O. STRIPPER / STAPLE REMOVER

TL175

P. 10" HEAVY DUTY SCISSORS

TL170

Q. 1/4" NUTSERT KITS

Includes 5/16" wood spade bit, 6 mm Hex key, and 12 nutserts. Installation instructions are included.
TL220

R. 1/4" NUTSERT

TL235

5/16" NUTSERT KIT

Includes 7/16" wood spade bit, 8 mm Hex key and 12 nutserts. Installation instructions are included.
TL240

5/16" NUTSERT

TL255

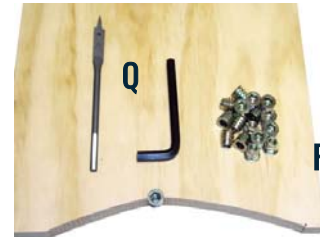

DUMBBELL REPAIRS

S. GP / AFS DUMBBELL REPAIR KIT

For use with GP & AFS dumbbells. Includes 2 flex handle breaker bars and 2 15/16" 6 point sockets.
TL115

SDH DUMBBELL REPAIR KIT

Includes 2 - 8" breaker bars.

T. TL100 With 2 5/16" allen head sockets.

U. TL125 With 2 3/8" allen head sockets.

V. LOCTITE #271

High strength thread locker. Color: Red

TL160 10 ml

TL159 1/2 ml

HEX KEYS

W. TL269 12 mm Hex Key

X. TL268 10 mm Hex Key



REPLACEMENT PADS

Replacement padding is our specialty.
We use only the best commercial quality materials to make your pads.



Plywood Bases

3/4" 7-ply Arauco plywood with beveled edges makes our pads durable and safe.

Densified Foam

As with our vinyl we also use only top quality bonded polyurethane foam. It meets or exceeds original manufacturers standards. It is available in a variety of thicknesses to fit your needs. Sold by the square foot, pricing is available upon request.

Vinyl

We use the same vinyl that most of the top manufacturers use including Boltaflex Colorguard, Boltaflex Grand Sierra and Naugahyde US Spirit Millennium. The vinyl is heavy-duty vinyl that has outstanding stain resistance and cleanability. It is available to purchase by the yard or roll. Pricing is available on our website FullCirclePadding.com.

Supplying manufacturers, clubs and the "Do It Yourselfer"

On-Site Upholstery (available throughout New England, New York City, Long Island and Northern New Jersey.)

This is our specialty. We will come to your club and conduct an evaluation. Upon approval, our crew will come back to your facility with half the work done (pads pre sewn, foam etc.) and complete the work in just a few hours.

Complete Pads

Thousands of pad patterns in stock for all major manufactures for shipping.

Sewn Up

Another option is sewn up covers for you to reupholster your own pads. We will send you the vinyl sewn and ready to be put onto your existing foam and plywood using your measurements.

Wear Covers

Where ever possible we put removable wear covers on heavily used pads. Once the cover wears out all you need to replace is the cover. Wear covers cost a fraction of what a complete pad would cost and it extends the life of your pads.

Embroidered Covers

Custom embroidered covers are available. Cost is approximately \$25.00 more per cover depending on logo. There is an additional charge to digitize the logo.

Edge Guards

We offer Nylon Edge Guards on many of the pads we manufacturer for free-weight benches and other pads that have a high risk of being damaged by dumbbells or other means. Please call for more information or look for specific benches or machines on our website FullCirclePadding.com

REPLACEMENT PADS

- Ⓢ Pricing for many manufacturers available online
- Ⓢ Order online, by phone or fax.
- Ⓢ If you don't see your equipment listed please call for prices.

Replacement pads from the manufacturers listed below are available for purchase online. If you do not see your machine online please call us with the information and we will let you know if we will need the measurements.

Because there are so many different companies out there making fitness equipment it is very difficult to keep up with and maintain pad information on all of them. In addition to that, some manufacturers have done pads differently on the same equipment, so we may need you to measure pads when ordering. There are easy to follow instructions in the catalog for you to use. Just remember that accurate measurements are very important, so please measure carefully.

All pads are non returnable. Due to the magnitude of replacement pads, colors and manufactures' we work with every pad is made to order. Full Circle Padding, Inc. is not responsible for incorrectly ordered colors or pads. The color charts online are not exactly the same shade as they appear on your screen. If you are not sure of the color please call our customer service department for assistance.

Ab Coaster	FreeMotion / Epic Strength	Medex	Simplicity
Ab Core	Gravitron 2000 Made by	Nautilus	Sports Art Fitness
Ab Solo	Stairmaster	Nebula	Stairmaster
Atlantis	Hammer Strength	Nordictrack	Star Trac (Flex)
Back Revolution	Hoist	Nustep	StretchMate
BFS	IM=X Fitness	Octane	Strive
Biodex	Icarian	Paramount	Tag
Body Masters	Keiser	Power Max	TechnoGym
Bodysolid	King Fitness	Power Lift	Tectrix
Booster / Elevation Pads	Legend Fitness	Power Plate	Total Gym
Champion Fitness	Leg Tech Butt Blaster	Precise Ab Trainer	Trotter
Cybox	Life Fitness	Precor	True
Diamondback	Magnum	Pro Maxima	Universal
Earthlite	Marpo	Quantum	Vision
Espresso	Matrix	Schwinn	York
Flex (See Star Trac)	Maxicam	SciFit	

HOW TO ORDER REPLACEMENT PADS

You need to have the following information available when ordering by phone, fax or online. You can also use the pad order form on page 67.

- **Manufacturer's name.**
- **Which line of equipment from that manufacturer you have.**
- **The model number.**

Each manufacturer puts the model number in a different place. If you do not have the model number please use our website to find the correct machine.

- **The type of machine.**
- **Which Pad is needed.**

Head,back,seat,chest,shoulder,elbow,arm,thigh,shin,ankle ect.

- **What is needed, complete pad or wear cover only.**
- **The color name and number.**

This is very important. We need this number for EVERY pad order that you place. If you do not have the name and number we may need you to cut a 1" clean sample from the bottom side of the pad and send it to us. We will let you know the color name and number so that you have it the next time you order.

- **Any order over 4 pads should be emailed or faxed.**

CUSTOM PADS

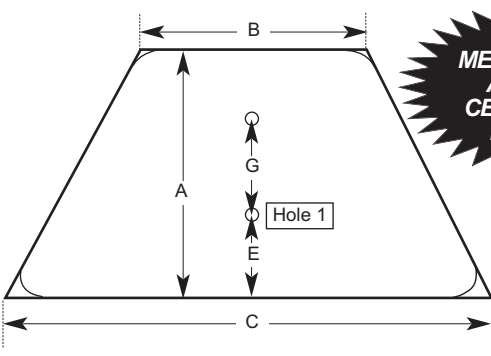
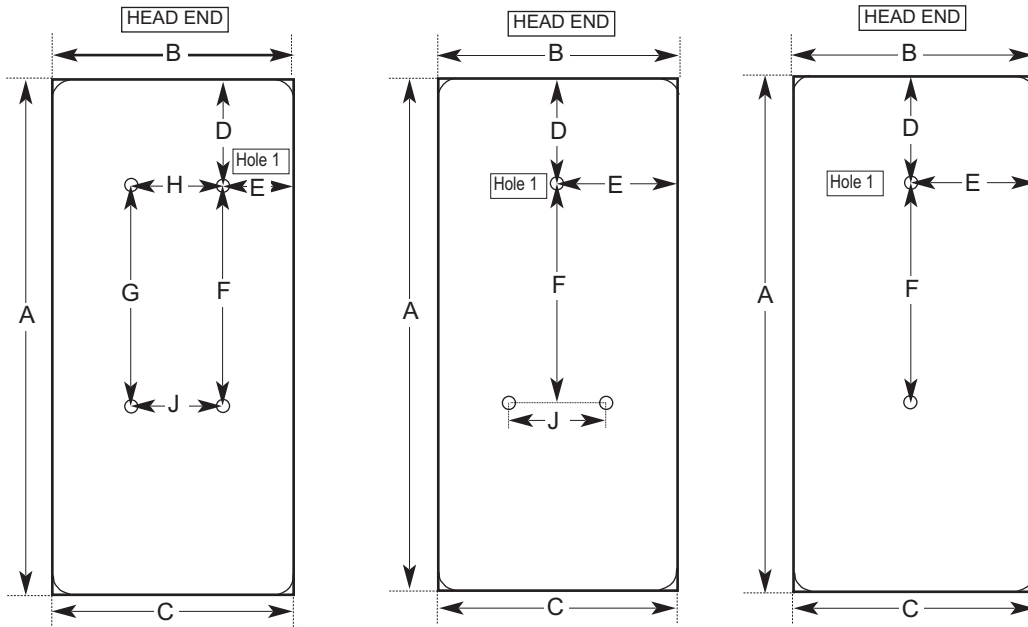

**ALL HOLE
MEASUREMENTS
ARE TO THE
CENTER OF THE
BOLT HOLE**

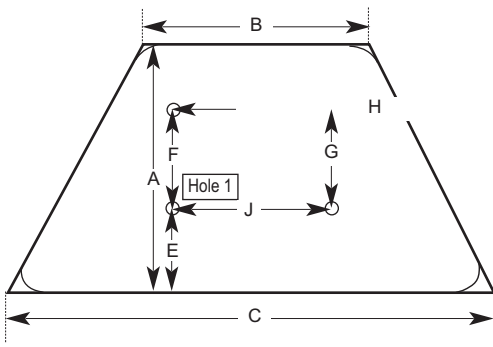
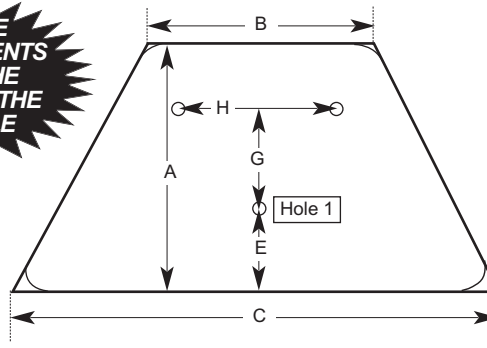

HOW TO MEASURE:

REMOVE PAD FROM MACHINE FOR ACCURATE HOLE PLACEMENT.

- Once pad is removed identify top (head end) of plywood.
- All measurements are in inches

- A. Actual length of wood
- B. Width of wood at (head end)
- C. 2nd width of wood if different than B.
- D. Distance from edge to center of first hole (hole 1)
- E. Distance from adjacent edge to center of first hole.
- F. Distance between holes (center to center)
- G. Distance between holes (center to center)
- H. Distance between holes (center to center)
- J. Distance between holes (center to center)
- K. Foam size is 3/4", 1", 1 1/4", 1 1/2" and 2". Do not include board thickness in your measurement. Standard plywood is 3/4"
- L. Specify bolt diameter.

ROLLER

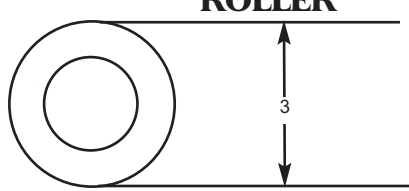

Remove roller from the machine to get an accurate length.

1. Length of roller - measure inner length.
2. Diameter of shaft roller rides on.
3. Outside diameter of roller.

Please measure and put dimensions on pad order sheet.

BOLT DIAMETER

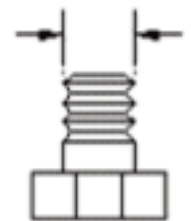



CUSTOM PAD ORDER SHEET

Club Name: Phone Number:

Contact: Fax Number:

Address Email:

City, State, Zip: Customer ID:

Using the instructions on the previous page, please measure the pad for which you need a replacement and draw a diagram with the measurements in the space provided. Please call with any questions: 1-800-875-7780 or email: brian@fullcirclepadding.com
 Fax your completed diagrams to 508-285-2502.

Your diagram should have the measurements filled in like the samples below.

Manufacturer Machine Model # Serial #

Pad Position Shape of Pad
(head, back, seat, chest, shoulder, elbow, arm, thigh, shin, ankle) (roller, square, half moon, rectangle, rectangle with angle sides)

Color: Complete Pad Wear Cover only

Your diagram should have the measurements filled in like the samples below.

Manufacturer Machine Model # Serial #

Pad Position Shape of Pad
(head, back, seat, chest, shoulder, elbow, arm, thigh, shin, ankle) (roller, square, half moon, rectangle, rectangle with angle sides)

Color: Complete Pad Wear Cover only



PAD ORDER FORM

Date: _____ Customer ID: _____

Filled out by: _____

Bill To:

Ship To:

Company Name: _____	Company Name: _____
Address _____	Address _____
City, State Zip: _____	City, State Zip: _____
Contact Name: _____	Contact Name: _____
Phone Number: _____	Phone Number: _____
Fax Number: _____	Fax Number: _____
Email: _____	Email: _____

QTY	PART #	MANUFACTURER	MACHINE	MODEL #	PAD DESCRIPTION	COLOR NAME & NUMBER

NOTES

PAYMENT TERMS

C.O.D. Net 30 PO # _____
 Charge My MasterCard Visa American Express
 Card Number: _____ Exp. Date _____
 V Code*: _____ Card cannot be processed without this number.
 Name on card: _____





Full Circle Padding, Inc.

253 Mansfield Avenue
 Norton, MA 02766
 (508) 285-2500 Toll Free 1-800-875-7780
 Fax (508) 285-2502
 www.fullcirclepadding.com

SOLD TO:

Name: _____
 Address: _____
 City: _____ State: _____ Zip: _____ C
 Contact: _____
 Phone: _____

SHIP TO:

Name: _____
 Address: _____
 City: _____ State: _____ Zip: _____
 Contact: _____
 Phone: _____

QUANTITY	PART NUMBER	DESCRIPTION	UNIT PRICE	TOTAL PRICE

PAYMENT TERMS

C.O.D - Full Circle will call you with a total including shipping when your order is ready to ship.

Card Number: _____
 Expiration Date: ____/____/____ V Code*: _____
 * On back of card Visa, Mastercard 3 digits in signature box, Front of American Express, four numbers above account. **Orders cannot be processed without this number.**

Signature: _____

We currently have credit terms set up. PO # _____

*If you would like to set up credit terms please contact us for an application

Sub Total Sales Tax Shipping	MA only	
Total*		

*Please note this total does not include shipping and handling charges.

Call for total including shipping.



Square Post Pad Quote Request

253 Mansfield Ave
Norton, MA 02766
www.fullcirclepadding.com
1-800-875-7780

Please complete form and provide images of area(s). Then email to

Carrie@fullcirclepadding.com or fax completed form to 508-285-2502

Bill To:	Ship To:
Company Name _____	Company Name _____
Address: _____	Address: _____
City _____ State _____ Zip: _____	City _____ State _____ Zip: _____
Contact Name: _____	Contact Name: _____
Phone Number (____) _____	Phone Number (____) _____
Fax Number: (____) _____	Fax Number: (____) _____
Cell Number: (____) _____	Cell Number (____) _____
Email Address: _____	Email Address: _____

Commercial Residential Address / School Address

Most orders will ship by truck with a tailgate delivery. The truck driver is only responsible for moving the pads to the end of the trailer. You will be responsible for removing the pads from the truck, checking them over for damage and bringing them inside. You must check carefully for damage and note it on the bill of lading before the driver leaves. Any damage reported after the driver leaves will not be covered.

Information needed for square or rectangle post is listed below Fill in measurements of post on diagram. If you require pricing on more than one post please measure each post. When measuring, measure carefully and double check your measurements. **Pads are made to order and are not returnable.**

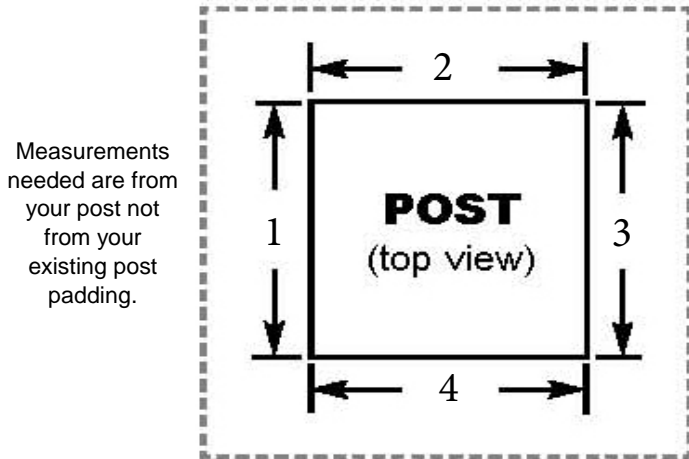

Quantity: _____ Closure Type Velcro Grommets

Measurement 1: _____ Measurement 2: _____ Measurement 3: _____ Measurement 4: _____

Height of Pad: _____ 6' High is the most common. Any custom size can be made.

Foam Thickness: _____ 4" Polyurethane foam is standard, 2" polyurethane foam is also available.

Check here for information about custom digital graphics.

If you have any questions please call us at 1-800-875-7780 or email Carrie@fullcirclepadding.com



Round Post Pad Quote Request

253 Mansfield Ave
Norton, MA 02766
www.fullcirclepadding.com
1-800-875-7780

Please complete form and provide images of your area(s). Then email to

Carrie@fullcirclepadding.com or fax completed form to 508-285-2502

Bill To:

Ship To:

Company Name _____

Company Name _____

Address: _____

Address: _____

City _____ State _____ Zip: _____

City _____ State _____ Zip: _____

Contact Name: _____

Contact Name: _____

Phone Number (____) _____

Phone Number (____) _____

Fax Number: (____) _____

Fax Number: (____) _____

Cell Number: (____) _____

Cell Number (____) _____

Email Address: _____

Email Address: _____

Commercial Residential Address / School Address

Most orders will ship by truck with a tailgate delivery. The truck driver is only responsible for moving the pads to the end of the trailer. You will be responsible for removing the pads from the truck, checking them over for damage and bringing them inside. You must check carefully for damage and note it on the bill of lading before the driver leaves. Any damage reported after the driver leaves will not be covered.

Information needed for round post pads is listed below Fill in measurements of post on diagram. If you require pricing on more than one post please measure each post. When measuring, measure carefully and double check your measurements. **Pads are made to order and are not returnable.**

Measurements needed are from your post not from your existing post padding.

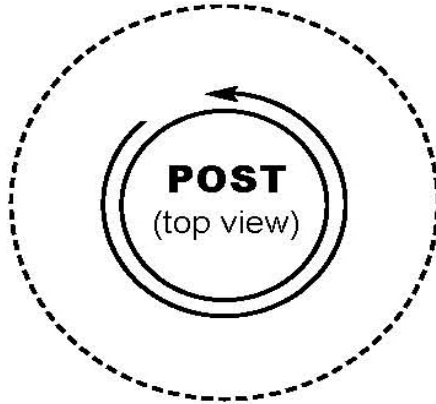

To measure the circumference wrap a piece of string around the post and measure the string.



Quantity: _____ Closure Type Velcro Grommets

Height of Pad: _____ 6' High is the most common. Any custom size can be made.

Circumference of Post: _____

Round post pads are only available with 4" polyurethane foam.

Check here for information about custom digital graphics.

If you have any questions please call us at 1-800-875-7780 or email Carrie@fullcirclepadding.com



I Beam Pad Quote Request

253 Mansfield Ave
Norton, MA 02766
www.fullcirclepadding.com
1-800-875-7780

Please complete form and provide images for your area(s). Then email to

Carrie@fullcirclepadding.com or fax completed form to 508-285-2502

Bill To:

Ship To:

Company Name _____
Address: _____
City _____ State _____ Zip: _____
Contact Name: _____
Phone Number (____) _____
Fax Number: (____) _____
Cell Number: (____) _____
Email Address: _____

Company Name _____
Address: _____
City _____ State _____ Zip: _____
Contact Name: _____
Phone Number (____) _____
Fax Number: (____) _____
Cell Number (____) _____
Email Address: _____

Commercial Residential Address / School Address

Most orders will ship by truck with a tailgate delivery. The truck driver is only responsible for moving the pads to the end of the trailer. You will be responsible for removing the pads from the truck, checking them over for damage and bringing them inside. You must check carefully for damage and note it on the bill of lading before the driver leaves. Any damage reported after the driver leaves will not be covered.

Information needed for I Beam padding is listed below. Fill in measurements of beam on diagram. If you need to cover four sides of the beam you need a square post pad. If you require pricing on more than one post please measure each post. When measuring, measure carefully and double check your measurements. **Pads are made to order and are not returnable.**

Beam 1

If your I beam is sticking out of a wall you need an I beam pad.

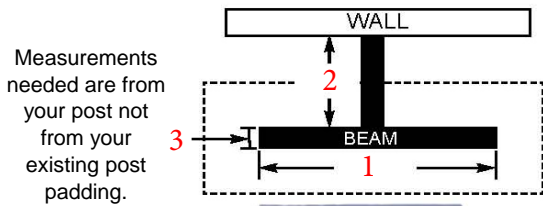

Beam 2

If you need to cover all four sides of an I beam, you need a square post pad.

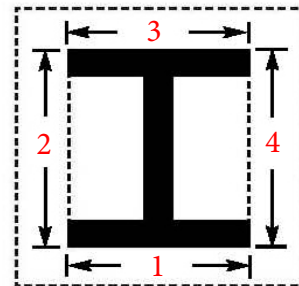

Quantity: _____

Beam 1:

Measurement 1: ____ Measurement 2: ____ Measurement 3: ____

or

Beam 2:

Measurement 1: ____ Measurement 2: ____ Measurement 3: ____ Measurement 4: ____

Height of Pad: _____ 6' High is the most common. Any custom size can be made.

Foam Thickness: _____ 4" Polyurethane foam is standard, 2" polyurethane foam is also available.

Check here for information about custom digital graphics.

If you have any questions please call us at 1-800-875-7780 or email Carrie@fullcirclepadding.com



Stage Pad Quote Request

253 Mansfield Ave
Norton, MA 02766
www.fullcirclepadding.com
1-800-875-7780

Please complete form and provide images of your area(s). Then e-mail to

Carrie@fullcirclepadding.com or fax completed form to 508-285-2502

Bill To:

Ship To:

Company Name _____

Company Name _____

Address: _____

Address: _____

City _____ State _____ Zip: _____

City _____ State _____ Zip: _____

Contact Name: _____

Contact Name: _____

Phone Number () _____

Phone Number () _____

Fax Number: () _____

Fax Number: () _____

Cell Number: () _____

Cell Number () _____

Email Address: _____

Email Address: _____

Commercial Residential Address / School Address

Most orders will ship by truck with a tailgate delivery. The truck driver is only responsible for moving the pads to the end of the trailer. You will be responsible for removing the pads from the truck, checking them over for damage and bringing them inside. You must check carefully for damage and note it on the bill of lading before the driver leaves. Any damage reported after the driver leaves will not be covered.

Information needed for stage padding is listed below. Fill in measurements for the stage below. Stage pads will have Velcro sewn to the back with self adhesive attached. When measuring, measure carefully and double check your measurements. Pads are made to order and are not returnable.

Measure the stage itself not existing padding.

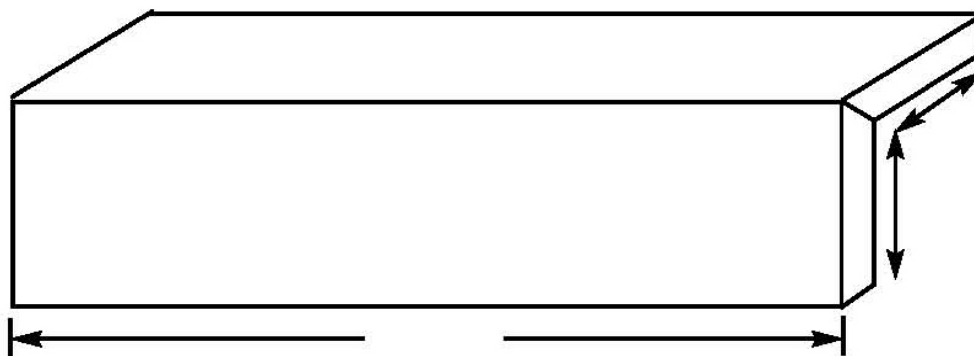

Foam Thickness: 1 3/8" Crosslink foam

Check here for information about custom digital graphics.

If you have any questions please call us at 1-800-875-7780 or e-mail Carrie@fullcirclepadding.com

WALL PAD QUOTE REQUEST



253 Mansfield Ave
Norton, MA 02766
www.fullcirclepadding.com
1-800-875-7780

Please complete form and provide images of your area(s). Then e-mail to Carrie@fullcirclepadding.com or fax form to 508-285-2502

Bill To:

Company Name _____
 Address: _____
 City _____ State _____ Zip: _____
 Contact Name: _____
 Phone Number (____) _____
 Fax Number: (____) _____
 Cell Number: (____) _____
 Email Address: _____

Ship To:

Company Name _____
 Address: _____
 City _____ State _____ Zip: _____
 Contact Name: _____
 Phone Number (____) _____
 Fax Number: (____) _____
 Cell Number (____) _____
 Email Address: _____

Commercial / School Address Residential Address

With some basic information we can give you an estimate for the padding including shipping. We need the following information:

1. The length of each wall to be covered:

	Wall 1 _____	Wall 2 _____
	Wall 3 _____	Wall 4 _____
	Wall 5 _____	Wall 6 _____
	Wall 7 _____	Wall 8 _____

- 2. The height of the wall pads. Standard sizes are 5, 6, and 7' high but any custom size can be made _____
- 3. How many cutouts are needed for outlets, switches vents? All cutouts are done at the factory. _____
- 4. Do you want digital graphics? If yes how many 2' wide pads would you like graphics on? _____
- 5. Do you need any round or square post pads, or I beam pads needed? Measurements are required for these, please use the appropriate how to measure page. _____
- 6. Are there any corner pads that are needed? We need the inside measurement of each side of corner _____
- 7. Our standard wall mat has FR 16oz vinyl and 2" CAL117B foam and will meet most local fire codes. _____
- 7A. Do you need ASTM E84 Class A Fire Rated wall padding? Please check with your local fire officials to see if this is required. _____
- 8. Installation is available throughout New England, New York City, Long Island and Northern New Jersey. Do you need installation? _____
- 9. Do you need Z-Channel for installation? _____
- 10. Please attach pictures of area(s) to be covered for accuracy.

-Wall padding is manufactured and shipped directly to you by truck. Allow approximately 5 - 6 weeks for delivery from the time of final approval. This may change during peak times. At time of delivery someone must be available to meet the truck, remove the mats and bring them inside. The truck driver is not obligated to help. The truck driver is only responsible for moving the pads to the end of the trailer. You will be responsible for removing the pads from the truck, checking them over for damage and bringing them inside. You must check carefully for damage and note it on the bill of lading before the driver leaves. Any damage reported after the driver leaves will not be covered.

-Pads being installed by Full Circle will be shipped to our warehouse and delivered by us at the time of installation.

-If Full Circle is installing the padding a representative will come to the facility to do the actual measurements. Measuring charges may apply. (Installation only available in New England, New York City, and northern New Jersey.)

If you have any questions please call us at 1-800-875-7780 or email Carrie@fullcirclepadding.com

ORDERING

We are committed to 100% customer satisfaction and want to make ordering as easy as possible. There are four ways of ordering, by phone, by fax, online or email.

ONLINE

We accept online orders 7 days a week 24 hours a day. We use industry standard SSL technology to protect your privacy and credit card information while your order is in transit. For customers who choose to register when they checkout we offer the convenience of Order Tracking. Simply login to your account, click Order Tracking and select the order, which you are inquiring about to find out if your order has been shipped and to obtain the UPS tracking number.

PHONE

Please call us at 1-800-875-7780 Monday through Friday 8am to 4pm if you would like to place an order by phone or if you have any questions.

FAX

You can also fax orders to us at (508) 285-2502 7 days a week 24 hours a day.

EMAIL

Orders can be emailed to customerservice@fullcirclepadding.com.

PAYMENT

Credit Cards

We accept Visa, MasterCard and American Express. When using credit cards, we require the following information:

Account number
Cardholder's name
Billing address
V code
Expiration date

Orders with incomplete credit card information cannot be processed and your order will be delayed. Orders with declined bank authorization will not be processed. If a card is declined your order will not ship, we will contact you to check the card information or to get new card information. For these reasons, and to ensure your protection, all credit card orders must include your name, address, telephone number and valid email address.

COD

COD shipping is available when ordering by phone. When your order is ready to ship, you will be contacted with a COD total including shipping and UPS COD charge. If we have to leave a message for you with the total please call to confirm, we cannot ship out your order without verbal confirmation.

Net 30 or Net 30 with PO

Customers who have filled out a credit application and have been approved by Full Circle will be set up on terms. Terms are Net 30. If a purchase order is required by your accounts payable department we must be given that number at the time the order is placed. We reserve the right not to ship any order if an account is past due, or revoke credit terms if bills are consistently not paid within terms.

SHIPPING

We offer three convenient UPS shipping methods for you to choose from. Shipping times listed are days in transit only and do not include order processing time.

UPS Ground (5-7 business days)
UPS Second Day Air
UPS Next Day Air

- Next Day Air and Second Day orders for in stock parts and accessories placed after 12:00 pm EST will ship the next business day.
- All in stock parts and accessory orders will ship within 1-2 business days. Most cable orders placed by 12:00 pm EST will ship within 24 hours.
- Pad orders generally ship in 7 - 10 business days, but may vary depending on order volume. Larger orders may take longer. Feel free to call or email to inquire about your projected ship date once your pad order is placed.
- All products purchased through our online catalog, weighing

more than 40 Lbs. such as olympic bars, will be shipped separately. All products weighing 40 lbs. will be shipped in multiple boxes, each box in the shipment weighing 70 Lbs or less.

RUSH ORDERS

We make will make every effort to accommodate requests for rush orders. Please call us at 1-800-875-7780 for more information. Rush charges may apply.

INTERNATIONAL ORDERS (outside the USA)

At this time international orders can only be placed by phone, fax or email.

All international (outside the USA) customers are subject to applicable sales tax, duty and customs charges determined by your local government. Full Circle Padding has partnered with Global-e Smart Cross Borders to calculate these additional charges so you know the complete shipping charges prior to

DROP SHIPS



Items that ship direct from the manufacturer will be marked with as drop ship or will say in the description that it ships direct from the manufacturer.. Some items will ship via UPS or Fed Ex and large orders, heavy weighted orders or oversized items will ship by truck. You will be notified if an order is shipping by truck. If a call ahead to arrange delivery or a liftgate delivery to lower the product to the ground is needed Full Circle should be notified at the time order is placed. Additional charges will apply.

Orders shipped as a tailgate delivery are moved to the end of the truck by the driver then it is the customers responsibility to take the product(s) from the truck and bring them inside. The truck driver is not required to assist you in getting the items off of the truck.

When unloading the products you should check over the packaging to be sure that there is no damage that may have been caused in shipping. Be sure to check all sides of packaging. If

there is damage it MUST be noted on the bill of lading before you sign for the delivery. Full Circle Padding should be notified of damage so that replacement product(s) can be sent if needed. Damage reported after the driver leaves will not be covered.

If you require a liftgate delivery we must be notified at the time of ordering or approval of your quote. Additional shipping charges will apply. Liftgates are not available for every delivery. A liftgate will lower your product(s) to the ground and you are responsible for moving them into the facility. Be sure to check them over for damage as described above.

if you require a call ahead for delivery to arrange a specific delivery time window we must be notified at the time of ordering or approval of the quote. Provide us with a phone number that is the best way to contact you about the delivery. The trucking company will call you to arrange the delivery. Additional charges will apply.

RETURN POLICY

PADS

All pads are non returnable. Due to the magnitude of replacement pads, and the variety of colors and manufactures' we work with every pad is made to order. Full Circle Padding, Inc. is not responsible for incorrectly ordered colors or pads. The color charts online are not exactly the same shade as they appear on your screen. Manufacturers may have several lines of equipment with different pads on similar machines. If you are not sure of the color, specific pad or if additional assistance is needed contact us directly at 1-800-875-7780

CABLES

Cables and pulleys are not returnable. Due to the magnitude of different manufacturers and replacement cables we work with each cable is made to order. Full Circle Padding, Inc. is not responsible for incorrectly ordered cables. Manufacturers may have several lines of equipment that may look similar but have different cables. If additional assistance is needed, please contact us directly at 1-800-876-7780.

STRETCH MATS

All stretch mats are made to order and are not returnable. Free samples are available for product inspection and color choice upon request.

Returns for all other products must be completed within 30 days of the original sale date. Up to a 40% restocking fee may apply. Please contact us for exact charge depending on the product.

All shipments must be inspected and checked for damage or shortages at the time of delivery. Any discrepancies must be noted on the bill of lading or delivery receipt before signing for it. The box and all packaging must be kept for UPS or Carrier inspection. Full Circle Padding is not responsible for damage or loss in transit. Please notify our customer service department of any shortages or damages upon receipt of your order.

Warranty information for individual items can be furnished upon request.

All returns must be pre-approved by customer service. Return Authorization #'s must be obtained and shipped with each package for return. Upon receipt and inspection of the product, any credits will be applied if applicable. Restocking fees may apply.

All shipping expenses are the responsibility of the customer unless customer service determines otherwise and depending on the circumstances of the return.

Full Circle customer service can be contacted at:
1-800-875-7780
customerservice@fullcirclepadding.com

Customer service hours are Monday - Friday 8:00 am - 4:00pm.

Returns with RA #'s should be sent to:
Full Circle Padding, Inc.
253 Mansfield Ave
Norton, MA 02766

FULL CIRCLE HAS GOT YOU COVERED!



On-site Evaluations

One of our experienced representatives will come to your facility to do a thorough evaluation of your pads, cables, grips, and grip tape.

Professional On-site Upholstery Installation

Available throughout New England, Long Island, New York City and Northern New Jersey. This service provides the most uninterrupted service for your members. Our technicians have been trained in all aspects of upholstery and we are fully insured.

Replacement Pads

By using only the best vinyl and foam we are able to provide you with the best replacement pads for any kind of equipment. Cybex, Nautilus, Hammer, Icarian, LifeFitness to name a few and any size custom size pad. You can also add your embroidered logo on your wear covers for a custom look.

Replacement Parts

Cables, pulleys, belting, grips, grip tape, weight pins, pop pins, weight stack stickers, seat belts, and lots more.

Gymnasium Wall Padding

Our high quality wall padding is available in several different colors and each job is customized according to the customers needs. Full color custom digital graphics are also available using your logo.

Quality Accessories

We carry a wide variety of accessories including products for yoga, aerobics and group exercise, dumbbells, cable attachments and more.

Rubber Flooring

Replacing a small area or a large area is easy with our wide selection of rubber flooring.

Stretch & Landing Mats

We have many different sizes available from individual 2' x 4' to room size mats.

Office / Production
253 Mansfield Ave
Norton, MA 02766

Phone 508-285-2500
Toll Free 1-800-875-7780
Fax 508-285-2502

www.FullCirclePadding.com
info@FullCirclePadding.com